



# Helios<sup>collection</sup>

Price Book 2010

ARK



---

Table of Contents	
Terms and Conditions of Sale	2
General Specifications	5
Attributes and Characteristics	6
Conceptual Configurations	7
Desk Tables	14
Auxiliary Tables	16
Work Tops	18
Connecting Worktops	22
Auxiliary Tables, Junction Tops, Top Supports, Legs	26
Mobile and Worktop Pedestals	28
Towers	30
Shelves, Shelf Supports, Accessories	46
Conference Tables	48
Voice/Data/Power Options	50

---

---

## Terms and Conditions of Sale

---

### Prices

All prices herein are delivered list prices effective the date printed on the cover and supersede all other published price lists.

Prices shown are for standard product only. Standard product will have additional charges applied to it for any changes made. Architectural Response Kollection, Inc. reserves the right to change prices and specifications without prior notice.

Pricing shown does not include installation, taxes, packaging, crating or storage. Orders are acknowledged with net prices. Minimum order charge is \$50 net.

---

### Acknowledgement

Each order will be acknowledged. This acknowledgement is the final agreement between Architectural Response Kollection, Inc. and the customer, superceding all previous communications regarding the order.

---

### Product Design

Architectural Response Kollection, Inc. reserves the right to make changes in design and construction or discontinue products without prior notice.

---

### Terms

Our terms are Net 30 days. Credit references and resale certificate must be submitted prior to receipt of your initial order. Open account status or terms of sale may be established at the discretion of Architectural Response Kollection, Inc.

After 30 days from date of invoice a 1 1/2% interest charge will be added on any unpaid balance. Architectural

Response Kollection, Inc. may retain a security interest in the furniture until full payment of the invoice.

---

### Ordering Procedures

Orders should be submitted through our authorized Factory Representative or may be sent directly to:

Architectural Response Kollection, Inc.  
2918 Halladay Street  
Santa Ana, California 92705

Tel. 714 241.7100  
Toll-free 888 241.7100  
Fax. 714 241.7600

---

### Cancellations and Changes

Request for cancellation and changes will be accepted if they are of a reasonable nature as determined by Architectural Response Kollection, Inc., and they are received in written form prior to the start of production. To cancel an order a fee of 25% or more may be imposed at our discretion. Change orders for products in production are based on our ability to conform and will also be subject to an appropriate fee to be based on our expenses. Special product orders may not be cancelled.

---

### Packing

All prices are for blanket wrap. For special packing requirements, contact the sales office. All weights stated herein are approximate. All products are shipped according to freight regulations. The ordering party bears the risk of loss or damage during shipment.

---

### Delivery and Freight Charges

All shipments are F.A.S. point of shipment, freight prepaid and allowed to one continental U.S. destination. All shipments outside the continental United States will be shipped FAS origin, freight prepaid to point of embarkation. All charges beyond point of embarkation are collect. Orders in production will be shipped as scheduled and cannot be held.

Architectural Response Kollection, Inc. reserves the right to select the most appropriate carrier and routing for all shipments.

Inside delivery and installation services are not included in the pricing shown.

Orders will be invoiced within 48 hours after notifying the customer of completion. If customer is unable to accept delivery of merchandise when ready for shipment, Architectural Response Kollection, Inc. may transfer the merchandise to storage. All costs including transportation will be at customers expense.

A storage charge of 1 1/2% of invoice will be assessed for every 30 days, or any part thereof, that merchandise remains in storage. Architectural Response Kollection, Inc. considers transfer to storage the equivalent of delivery for all purposes, including invoicing and payment. Customers will bear all risk of damage or loss during storage.

Architectural Response Kollection, Inc. is not liable for any delay for failure to deliver products due to: fires, floods, accidents, labor strikes, lock outs, earthquakes, delay or failure of material supply sources, acts of God, or any other causes beyond Architectural Response Kollection, Inc.'s control.

---

### Claims

---

Architectural Response Kollektion, Inc. takes every precaution to assure proper inspection of the loading and packing of all merchandise. Our liability ceases when we receive a clear bill of lading at our shipping dock. This is an acknowledgement by the transportation company that the merchandise was received in good condition.

---

### Damaged Merchandise

---

Do not refuse merchandise damaged in transit. All shipments are delivered to the transportation company in good condition. Architectural Response Kollektion, Inc.'s liability ceases at that time. If a shipment is received damaged you should immediately file a claim with the transportation company.

---

### Concealed Damage and Shortages

---

Customers are protected from concealed damage and shortages if they file claims with the carrier within five days of delivery. ARK suggests that the words "subject to inspection" accompany signature if goods are crated or cartoned and thus cannot be examined at time of receipt. Any claims for shipping damage must be filed by the customer with the carrier within five days of receipt.

---

### Repair Charges

---

Factory authorization must be secured from Architectural Response Kollektion, Inc. prior to incurring repair charges if Architectural Response Kollektion, Inc. is expected to pay these charges.

Merchandise may not be returned without our prior written authorization along with shipping instructions. Unauthorized returns will not be accepted and will be returned freight collect.

All merchandise being returned must be properly packed and protected to ensure no further damage is incurred during transportation back to Architectural Response Kollektion, Inc.'s facility. Upon receipt, all returned merchandise will be thoroughly inspected and the results compared to the reason for return stated on the RGA. Any discrepancies, such as additional damage, signs of usage, missing parts, etc., will result in an adjustment to the amount of credit issued.

---

### Warranty

---

All Architectural Response Kollektion, Inc. products are manufactured according to our high standards for fine quality materials and workmanship. We warrant all standard catalog items against failure due to defective materials or workmanship for a period of ten years of single shift service from the date of shipment.

This warranty does not apply to damages, neglect, misused or altered products, nor defects in materials not manufactured by Architectural Response Kollektion, Inc. Excluded from this warranty are leathers, marble and granite surfaces.

The manufacturer cannot guarantee any product, stored or set in place, in an environment where temperature and humidity are not controlled.

---

### Care and Maintenance

---

When cleaning, use a soft cotton cloth moistened with a mild soap and warm water solution and dry immediately. ARK does not recommend the use of waxes or polishes.

---

### Color and Grain Matching

---

Different wood species offer unique texture and grain. Variations in finish color and value may occur due to the natural characteristics of wood. Architectural Response Kollektion, Inc. carefully selects all materials used in every product to minimize the natural variation in materials. Exact color match is not possible.

When re-ordering furniture for an existing project, where color change has occurred as a natural part of the aging process, please provide sample if color matching is critical.



# Helios Kollektion

## Ordering Information and Accessories

### Standard Features

Locks – standard on all drawer pedestals. Black finish is standard.

Pulls – all 18" wide freestanding pedestal drawers and all doors have knobs. All 30" and 36" wide drawers and mobile pedestal drawers have pulls.

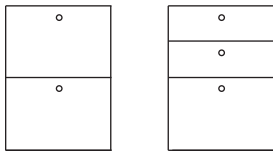

Freestanding Pedestals

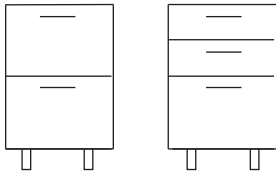

Mobile Pedestals

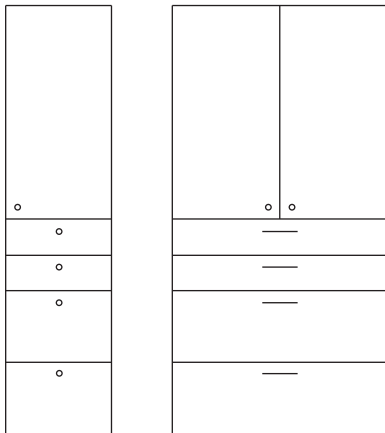

Towers

Box drawers have one fully adjustable drawer divider.

File drawers accommodate legal and letter hanging files.

Legs are black powder coated metal.

### Materials

Wood	Finish
Cherry	LC 501 Light Cherry
	MC 502 Medium Cherry
	DC 503 Dark Cherry
Maple	NM 400 Natural Maple
	HM 404 Honey Maple
	HM 405 Honey Maple

Standard finishes are in a 45 sheen.

Prices listed are with open pore finishes. Semi-filled tops are available at a 10% upcharge. Fully-filled tops are available at a 20% upcharge.

Most requests for special finishes can be accommodated at a 15% upcharge.

### Approved Fabric Choices:

- Maharam
- Tek-Wall 1000
  - Tek-Wall Merit
  - Tek-Wall Herald

- Guilford of Maine
- Donegal Tweed
  - FR701
  - Belgrade
  - Hopscotch

Included for the same price are COM fabrics approved by ARK.

### Helios Edge Detail

Worksurfaces - 1 1/4" solid hardwood band where user contact occurs.

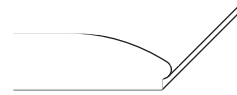

H01

### Helios Pulls



Knob

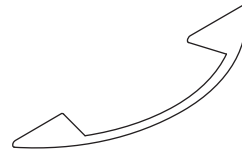

Pull

Attributes and Characteristics

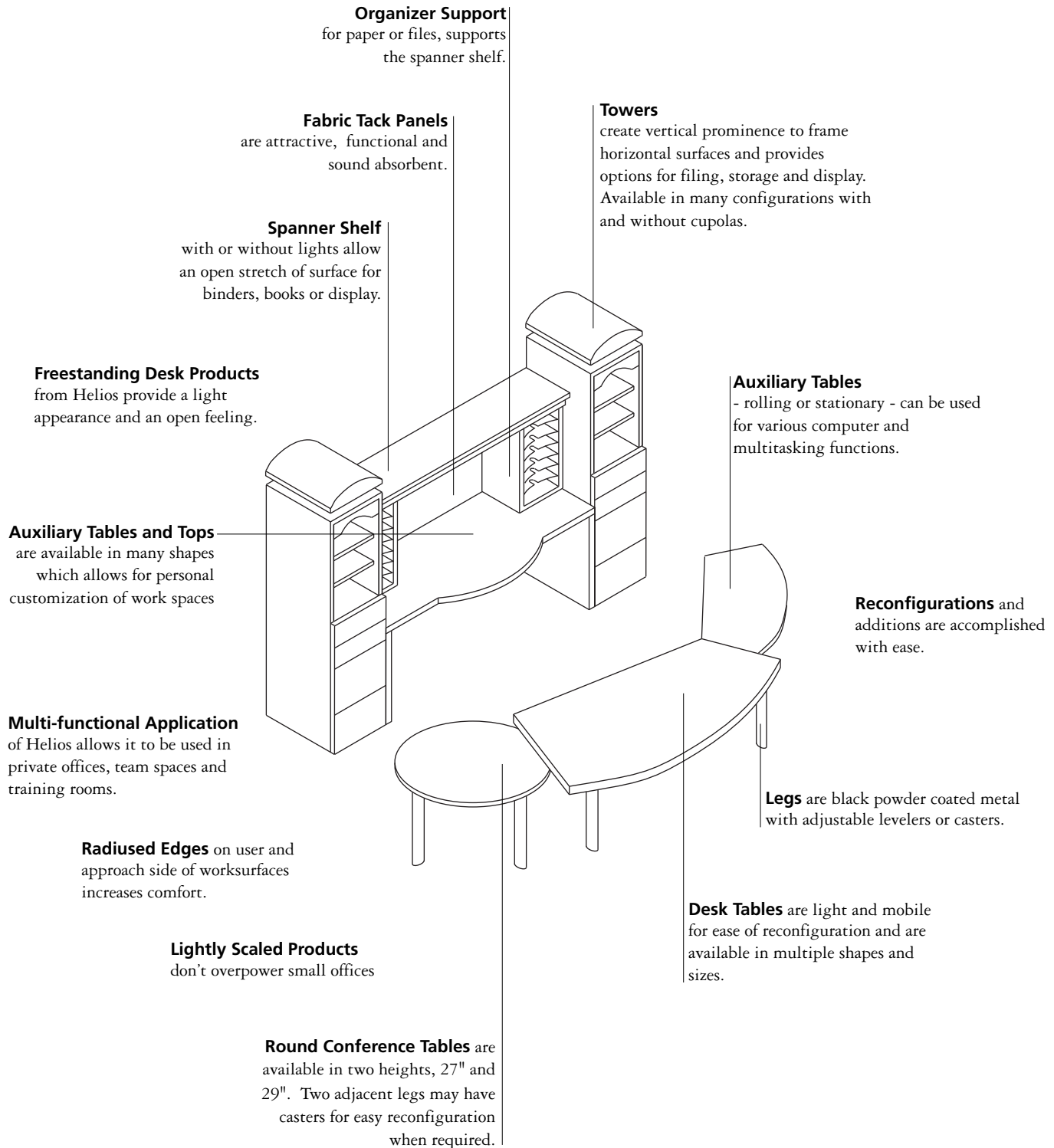

Conceptual Configurations

**A = Desk Table**

- Specifying pages 14- 15

**B = Auxiliary Table**

- Specifying pages 16, 17, 26

**C = Worktop**

- Specifying pages 18- 20

**D = Junction Top**

- Specifying pages 26- 27

**E = Pedestal**

- Specifying pages 28- 29

**F = Tower**

- Specifying pages 30- 45

**G = Shelf**

- Specifying page 46

**H = Support**

- Specifying page 46

**I = Tack Panel**

- Specifying page 47

**J = Modesty Panel**

- Specifying pages 27

**K = Lighting**

- Specifying page 47

**L = Lectern**

- Specifying page 47

**M = Presentation Board**

- Specifying page 47

**N = Conference Table**

- Specifying pages 48- 49

**O = Connecting Worktops**

- Specifying pages 22- 25

**P = Voice/Power/Data**

- Specifying page 50

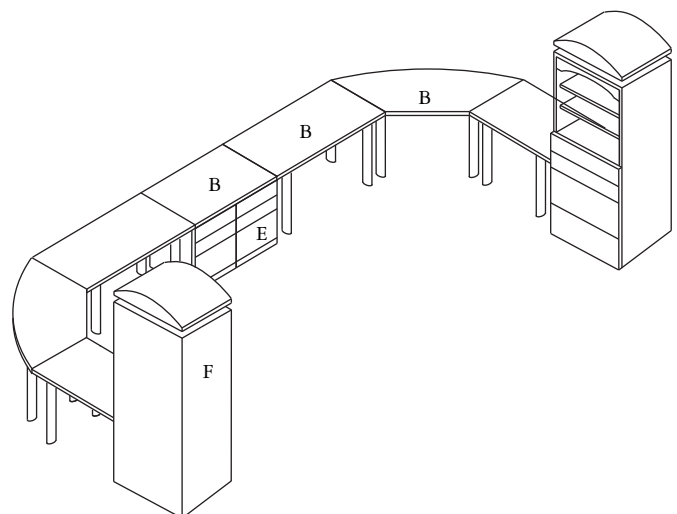
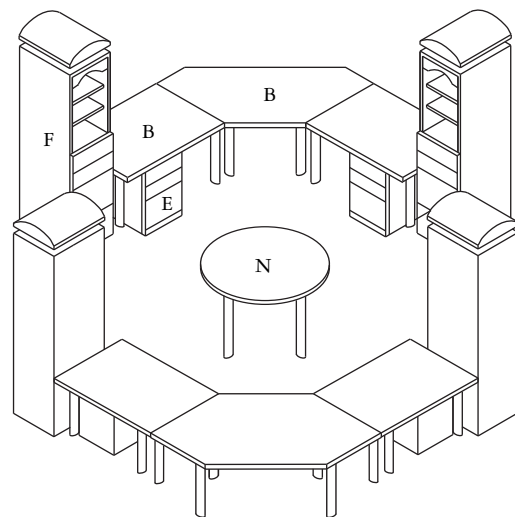
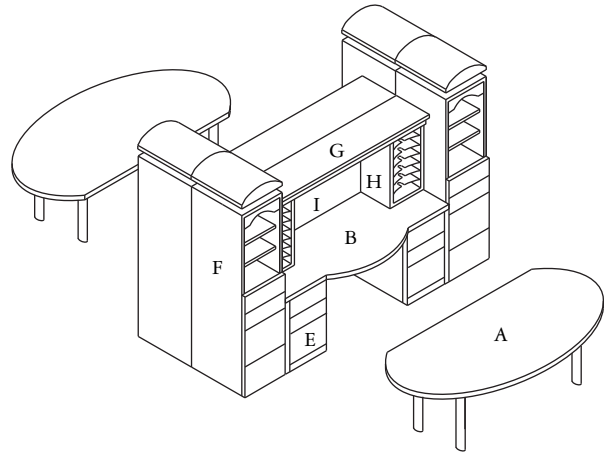

**A = Desk Table**

- Specifying pages 14- 15

**B = Auxiliary Table**

- Specifying pages 16, 17, 26

**C = Worktop**

- Specifying pages 18- 20

**D = Junction Top**

- Specifying pages 26- 27

**E = Pedestal**

- Specifying pages 28- 29

**F = Tower**

- Specifying pages 30- 45

**G = Shelf**

- Specifying page 46

**H = Support**

- Specifying page 46

**I = Tack Panel**

- Specifying page 47

**J = Modesty Panel**

- Specifying pages 27

**K = Lighting**

- Specifying page 47

**L = Lectern**

- Specifying page 47

**M = Presentation Board**

- Specifying page 47

**N = Conference Table**

- Specifying pages 48- 49

**O = Connecting Worktops**

- Specifying pages 22- 25

**P = Voice/Power/Data**

- Specifying page 50

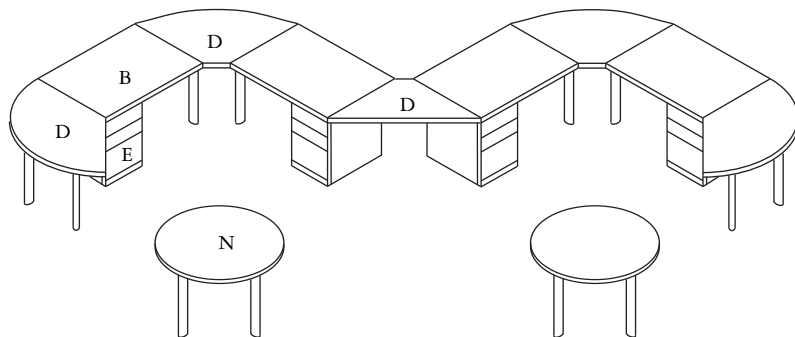
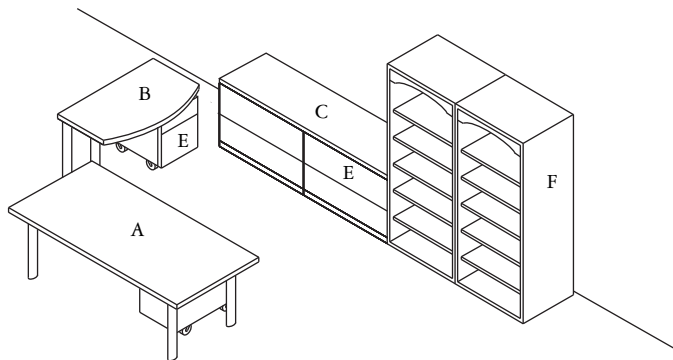
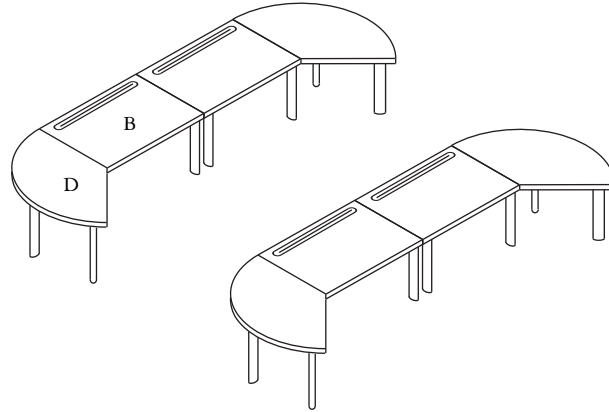

**A = Desk Table**

- Specifying pages 14- 15

**B = Auxiliary Table**

- Specifying pages 16, 17, 26

**C = Worktop**

- Specifying pages 18- 20

**D = Junction Top**

- Specifying pages 26- 27

**E = Pedestal**

- Specifying pages 28- 29

**F = Tower**

- Specifying pages 30- 45

**G = Shelf**

- Specifying page 46

**H = Support**

- Specifying page 46

**I = Tack Panel**

- Specifying page 47

**J = Modesty Panel**

- Specifying pages 27

**K = Lighting**

- Specifying page 47

**L = Lectern**

- Specifying page 47

**M = Presentation Board**

- Specifying page 47

**N = Conference Table**

- Specifying pages 48- 49

**O = Connecting Worktops**

- Specifying pages 22- 25

**P = Voice/Power/Data**

- Specifying page 50

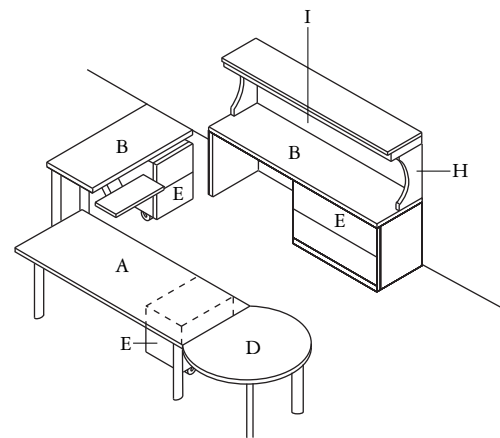
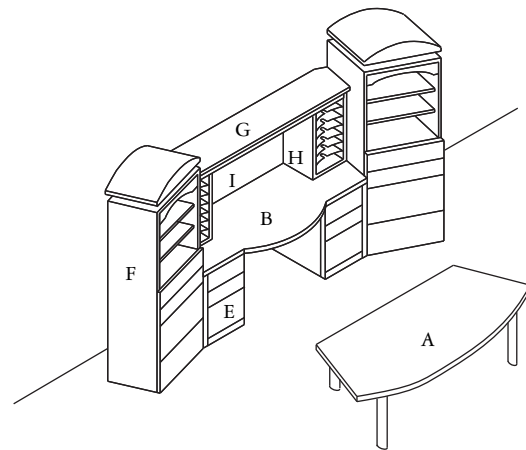
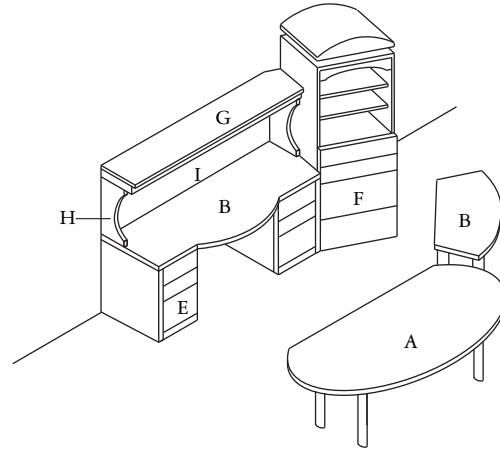

**A = Desk Table**

- Specifying pages 14- 15

**B = Auxiliary Table**

- Specifying pages 16, 17, 26

**C = Worktop**

- Specifying pages 18- 20

**D = Junction Top**

- Specifying pages 26- 27

**E = Pedestal**

- Specifying pages 28- 29

**F = Tower**

- Specifying pages 30- 45

**G = Shelf**

- Specifying page 46

**H = Support**

- Specifying page 46

**I = Tack Panel**

- Specifying page 47

**J = Modesty Panel**

- Specifying pages 27

**K = Lighting**

- Specifying page 47

**L = Lectern**

- Specifying page 47

**M = Presentation Board**

- Specifying page 47

**N = Conference Table**

- Specifying pages 48- 49

**O = Connecting Worktops**

- Specifying pages 22- 25

**P = Voice/Power/Data**

- Specifying page 50

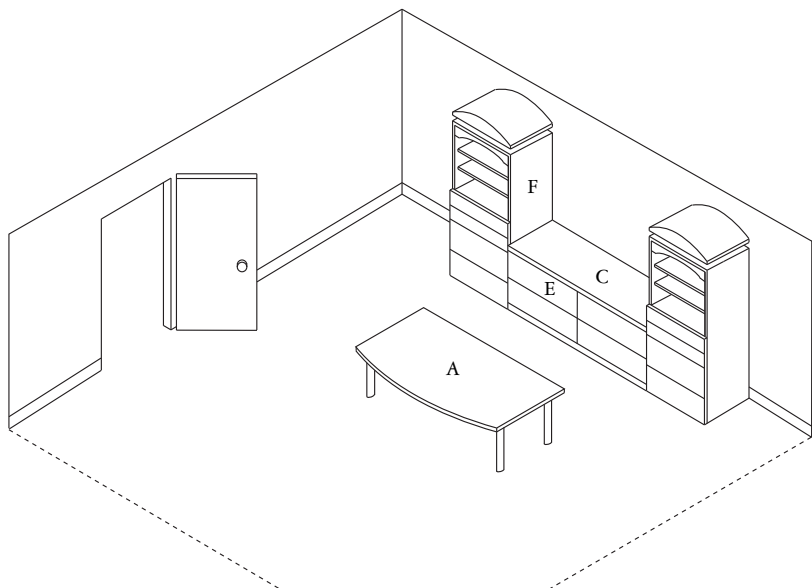
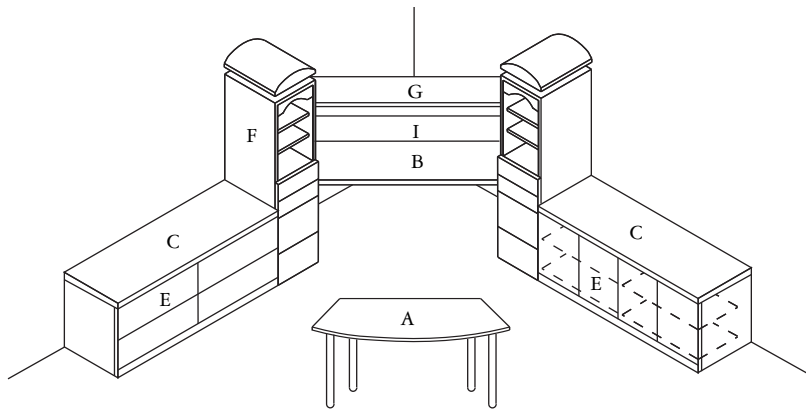
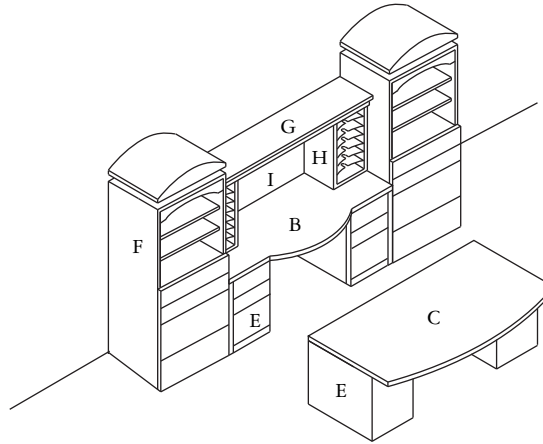

**A = Desk Table**

- Specifying pages 14- 15

**B = Auxiliary Table**

- Specifying pages 16, 17, 26

**C = Worktop**

- Specifying pages 18- 20

**D = Junction Top**

- Specifying pages 26- 27

**E = Pedestal**

- Specifying pages 28- 29

**F = Tower**

- Specifying pages 30- 45

**G = Shelf**

- Specifying page 46

**H = Support**

- Specifying page 46

**I = Tack Panel**

- Specifying page 47

**J = Modesty Panel**

- Specifying pages 27

**K = Lighting**

- Specifying page 47

**L = Lectern**

- Specifying page 47

**M = Presentation Board**

- Specifying page 47

**N = Conference Table**

- Specifying pages 48- 49

**O = Connecting Worktops**

- Specifying pages 22- 25

**P = Voice/Power/Data**

- Specifying page 50

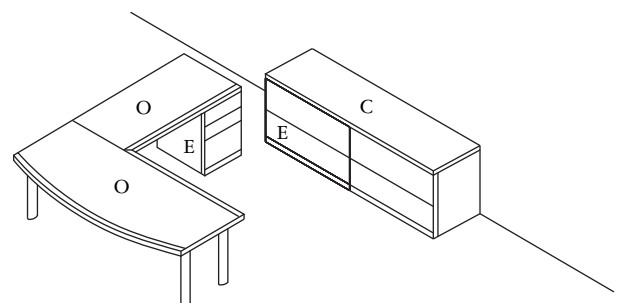
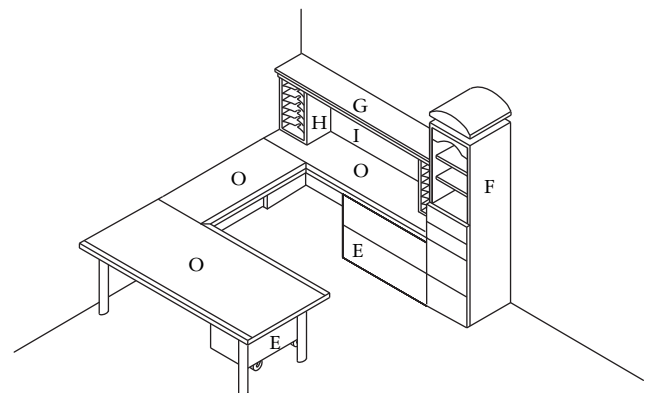
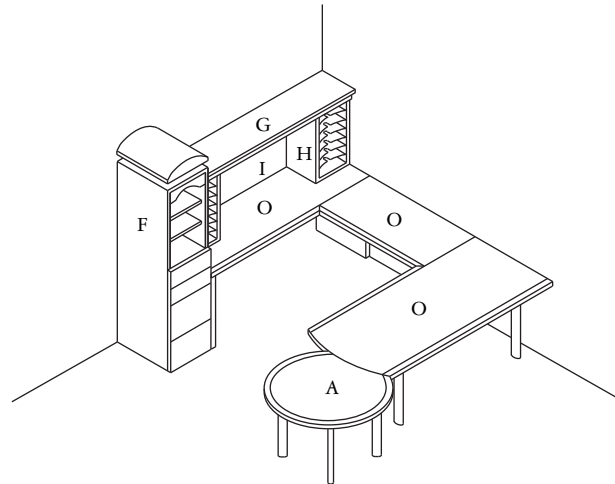

---

**A = Desk Table**

- Specifying pages 14- 15

**B = Auxiliary Table**

- Specifying pages 16, 17, 26

**C = Worktop**

- Specifying pages 18- 20

**D = Junction Top**

- Specifying pages 26- 27

**E = Pedestal**

- Specifying pages 28- 29

**F = Tower**

- Specifying pages 30- 45

**G = Shelf**

- Specifying page 46

**H = Support**

- Specifying page 46

**I = Tack Panel**

- Specifying page 47

**J = Modesty Panel**

- Specifying pages 27

**K = Lighting**

- Specifying page 47

**L = Lectern**

- Specifying page 47

**M = Presentation Board**

- Specifying page 47

**N = Conference Table**

- Specifying pages 48- 49

**O = Connecting Worktops**

- Specifying pages 22- 25

**P = Voice/Power/Data**

- Specifying page 50

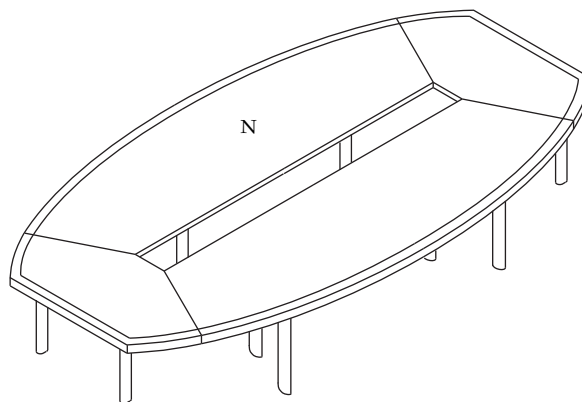
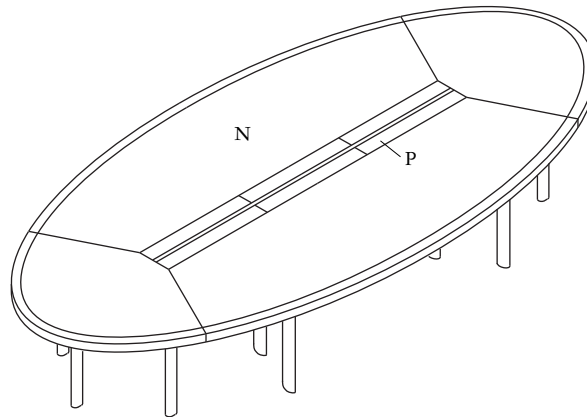
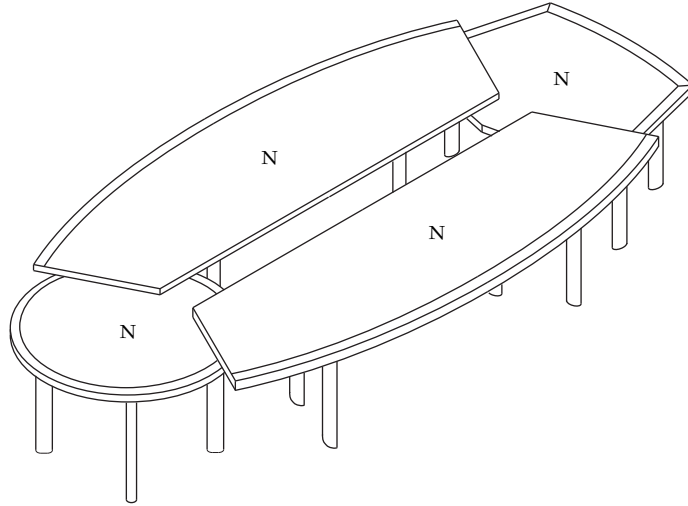

**A = Desk Table**

- Specifying pages 14- 15

**B = Auxiliary Table**

- Specifying pages 16, 17, 26

**C = Worktop**

- Specifying pages 18- 20

**D = Junction Top**

- Specifying pages 26- 27

**E = Pedestal**

- Specifying pages 28- 29

**F = Tower**

- Specifying pages 30- 45

**G = Shelf**

- Specifying page 46

**H = Support**

- Specifying page 46

**I = Tack Panel**

- Specifying page 47

**J = Modesty Panel**

- Specifying pages 27

**K = Lighting**

- Specifying page 47

**L = Lectern**

- Specifying page 47

**M = Presentation Board**

- Specifying page 47

**N = Conference Table**

- Specifying pages 48- 49

**O = Connecting Worktops**

- Specifying pages 22- 25

**P = Voice/Power/Data**

- Specifying page 50

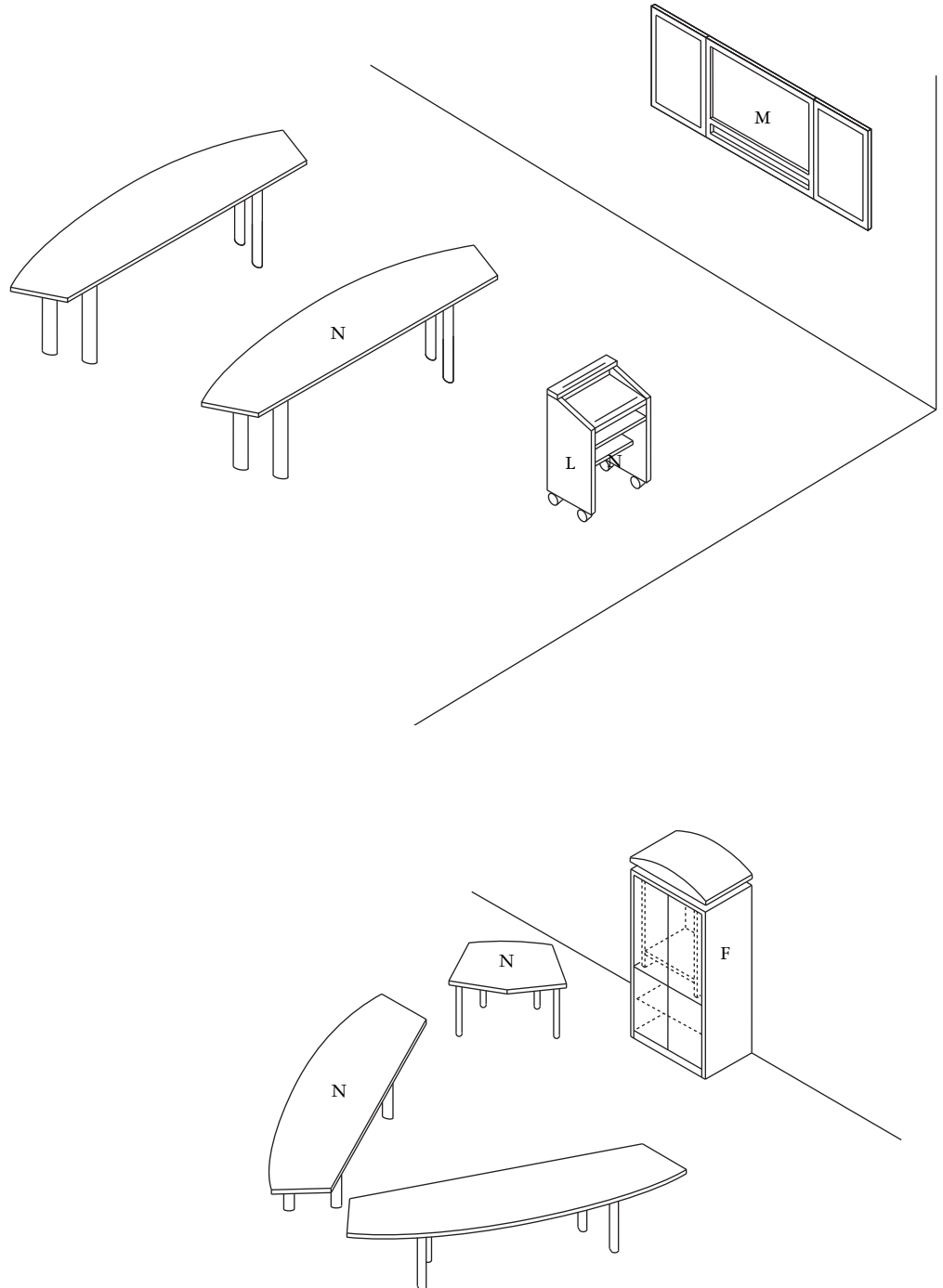

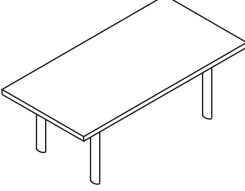
Model No.	Depth	Width	Height	Price	Cubic Feet	Weight		
<b>Straight Front Desk Table</b>								
		<b>H/SF-DT-3060</b>	30	60	29	2550	3.8	85
		<b>H/SF-DT-3066</b>	30	66	29	2700	4.0	90
		<b>H/SF-DT-3072</b>	30	72	29	2850	4.2	96
		<b>H/SF-DT-3078</b>	30	78	29	3050	4.4	102
		<b>H/SF-DT-3084</b>	30	84	29	3200	4.6	110
		<b>H/SF-DT-3660</b>	36	60	29	2850	4.0	95
		<b>H/SF-DT-3666</b>	36	66	29	3075	4.2	103
		<b>H/SF-DT-3672</b>	36	72	29	3250	4.4	110
		<b>H/SF-DT-3678</b>	36	78	29	3450	4.6	116
		<b>H/SF-DT-3684</b>	36	84	29	3675	4.8	124

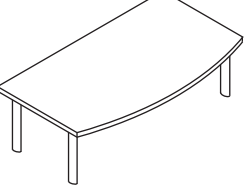
<b>Bow Front Desk Table</b>								
		<b>H/BF-DT-3060</b>	30	60	29	3000	3.8	85
		<b>H/BF-DT-3066</b>	30	66	29	3175	4.0	90
		<b>H/BF-DT-3072</b>	30	72	29	3325	4.2	96
		<b>H/BF-DT-3078</b>	30	78	29	3500	4.4	102
		<b>H/BF-DT-3084</b>	30	84	29	3675	4.6	110
		<b>H/BF-DT-3660</b>	36	60	29	3325	4.0	95
		<b>H/BF-DT-3666</b>	36	66	29	3550	4.2	103
		<b>H/BF-DT-3672</b>	36	72	29	3725	4.4	110
		<b>H/BF-DT-3678</b>	36	78	29	3925	4.6	116
		<b>H/BF-DT-3684</b>	36	84	29	4125	4.8	124

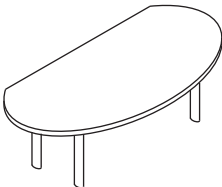
<b>Flat Oval Desk Table</b>								
		<b>H/FO-DT-3672</b>	36	72	29	4350	4.5	110
		<b>H/FO-DT-3678</b>	36	78	29	4675	5.0	117
		<b>H/FO-DT-3684</b>	36	84	29	4975	5.5	125
		<b>H/FO-DT-4284</b>	42	84	29	5300	6.0	140

Specify Model Number, Wood Finish, and Optional Accessories

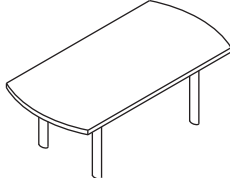
Model No.	Depth	Width	Height	Price	Cubic Feet	Weight
<b>Radius End Desk Table</b>						
	<b>H/RE-DT-3672</b>	36	72	29	3725	4.5 110
	<b>H/RE-DT-3678</b>	36	78	29	4050	5.0 117
	<b>H/RE-DT-3684</b>	36	84	29	4350	5.5 125
	<b>H/RE-DT-4284</b>	42	84	29	4975	6.0 140

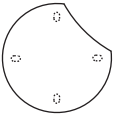
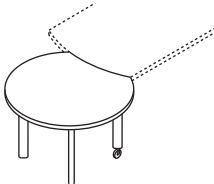
		Diameter				
<b>Round Crescent Auxilliary Table</b>						
	<b>H/RC-AT-36</b>	36	29	2350	6.0	70
	<b>H/RC-AT-42</b>	42	29	2625	6.5	80
	<b>H/RC-AT-48</b>	48	29	2950	7.0	90
<b>Fits Radius End Desk Table</b>						

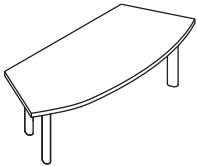
<b>Angle Bow Desk Table</b>						
	<b>H/AB-DT-3072</b>	30	72	29	3425	4.1 96
	<b>H/AB-DT-3084</b>	30	84	29	3725	4.3 108
	<b>H/AB-DT-3090</b>	30	90	29	4050	4.5 114
	<b>H/AB-DT-3096</b>	30	96	29	4675	4.6 120
	<b>H/AB-DT-3672</b>	36	72	29	3725	4.5 110
	<b>H/AB-DT-3684</b>	36	84	29	4050	5.0 125
	<b>H/AB-DT-3690</b>	36	90	29	4350	4.9 130
	<b>H/AB-DT-3696</b>	36	96	29	4675	5.0 138
	<b>H/AB-DT-4284</b>	42	84	29	4975	5.0 140
	<b>H/AB-DT-4296</b>	42	96	29	5300	6.0 156

Specify Model Number, Wood Finish, and Optional Accessories

Rectangular Straight Auxiliary Table

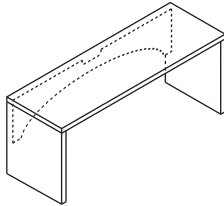

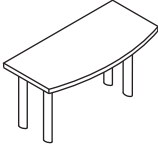

Model No.	Depth	Width	Height	Price	Cubic Feet	Weight
<b>H/RS-AT-2036</b>	20	36	29	1950	3.1	70
<b>H/RS-AT-2042</b>	20	42	29	2000	3.2	77
<b>H/RS-AT-2048</b>	20	48	29	2050	3.3	84
<b>H/RS-AT-2054</b>	20	54	29	2100	3.4	91
<b>H/RS-AT-2060</b>	20	60	29	2125	3.5	98
<b>H/RS-AT-2066</b>	20	66	29	2200	3.6	105
<b>H/RS-AT-2072</b>	20	72	29	2350	3.7	112
<b>H/RS-AT-2078</b>	20	78	29	2450	3.8	119
<b>H/RS-AT-2084</b>	20	84	29	2600	3.9	126
<b>H/RS-AT-2090</b>	20	90	29	2775	4.0	133
<b>H/RS-AT-2096</b>	20	96	29	2950	4.1	140
<b>H/RS-AT-20108</b>	20	108	29	3275	4.3	147
<b>H/RS-AT-2436</b>	24	36	29	2125	3.2	75
<b>H/RS-AT-2442</b>	24	42	29	2225	3.2	82
<b>H/RS-AT-2448</b>	24	48	29	2275	3.4	89
<b>H/RS-AT-2454</b>	24	54	29	2300	3.5	96
<b>H/RS-AT-2460</b>	24	60	29	2350	3.6	103
<b>H/RS-AT-2466</b>	24	66	29	2450	3.7	110
<b>H/RS-AT-2472</b>	24	72	29	2550	3.8	117
<b>H/RS-AT-2478</b>	24	78	29	2700	3.9	124
<b>H/RS-AT-2484</b>	24	84	29	2875	4.0	131
<b>H/RS-AT-2490</b>	24	90	29	3075	4.1	138
<b>H/RS-AT-2496</b>	24	96	29	3275	4.2	145
<b>H/RS-AT-24108</b>	24	108	29	3650	4.4	152

Specify Model Number, Wood Finish, and Optional Accessories

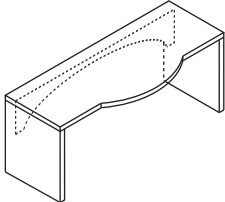
	Model No.	Depth	Width	Height	Price	Cubic Feet	Weight
<b>Bow Front Auxiliary Table</b>  	<b>H/BF-AT-2436</b>	24	36	29	2200	0.7	30
	<b>H/BF-AT-2442</b>	24	42	29	2350	0.8	35
	<b>H/BF-AT-2448</b>	24	48	29	2475	0.9	40
	<b>H/BF-AT-2454</b>	24	54	29	2625	1.0	45
	<b>H/BF-AT-2460</b>	24	60	29	2800	1.1	50
	<b>H/BF-AT-2472</b>	24	72	29	3100	1.3	55
	<b>H/BF-AT-2484</b>	24	84	29	3725	1.5	60

<b>Bubble Bow Auxiliary Table</b>  	<b>H/BB-AT-2472</b>	20/24	72	29	2500	1.1	55
	<b>H/BB-AT-2484</b>	20/24	84	29	2825	1.3	65
	<b>H/BB-AT-2496</b>	20/24	96	29	3200	1.5	75

<b>Angle Bow Auxiliary Table</b>  	<b>H/AB-AT-2442</b>	24	42	29	2350	0.7	30
	<b>H/AB-AT-2448</b>	24	48	29	2475	0.8	35
	<b>H/AB-AT-2454</b>	24	54	29	2625	0.9	40

Specify Model Number, Wood Finish, and Optional Accessories

Straight Front Work Tops

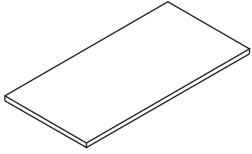

Model No.	Depth	Width	Height	Price	Cubic Feet	Weight
<b>H/SF-WT-3054</b>	30	54	1 <sup>1</sup> / <sub>4</sub>	1475	1.2	53
<b>H/SF-WT-3060</b>	30	60	1 <sup>1</sup> / <sub>4</sub>	1675	1.3	60
<b>H/SF-WT-3066</b>	30	66	1 <sup>1</sup> / <sub>4</sub>	1825	1.5	65
<b>H/SF-WT-3072</b>	30	72	1 <sup>1</sup> / <sub>4</sub>	1975	1.7	71
<b>H/SF-WT-3078</b>	30	78	1 <sup>1</sup> / <sub>4</sub>	2175	1.9	77
<b>H/SF-WT-3084</b>	30	84	1 <sup>1</sup> / <sub>4</sub>	2325	2.1	85
<b>H/SF-WT-3660</b>	36	60	1 <sup>1</sup> / <sub>4</sub>	1975	1.5	70
<b>H/SF-WT-3666</b>	36	66	1 <sup>1</sup> / <sub>4</sub>	2200	1.7	78
<b>H/SF-WT-3672</b>	36	72	1 <sup>1</sup> / <sub>4</sub>	2375	1.9	85
<b>H/SF-WT-3678</b>	36	78	1 <sup>1</sup> / <sub>4</sub>	2575	2.1	91
<b>H/SF-WT-3684</b>	36	84	1 <sup>1</sup> / <sub>4</sub>	2800	2.3	99

Bow Front Work Tops

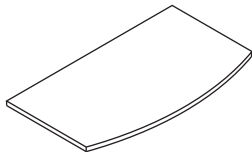

<b>H/BF-WT-3054</b>	30	54	1 <sup>1</sup> / <sub>4</sub>	1950	1.2	53
<b>H/BF-WT-3060</b>	30	60	1 <sup>1</sup> / <sub>4</sub>	2125	1.3	60
<b>H/BF-WT-3066</b>	30	66	1 <sup>1</sup> / <sub>4</sub>	2300	1.5	65
<b>H/BF-WT-3072</b>	30	72	1 <sup>1</sup> / <sub>4</sub>	2450	1.7	71
<b>H/BF-WT-3078</b>	30	78	1 <sup>1</sup> / <sub>4</sub>	2625	1.9	77
<b>H/BF-WT-3084</b>	30	84	1 <sup>1</sup> / <sub>4</sub>	2800	2.1	85
<b>H/BF-WT-3660</b>	36	60	1 <sup>1</sup> / <sub>4</sub>	2450	1.5	70
<b>H/BF-WT-3666</b>	36	66	1 <sup>1</sup> / <sub>4</sub>	2675	1.7	78
<b>H/BF-WT-3672</b>	36	72	1 <sup>1</sup> / <sub>4</sub>	2850	1.9	85
<b>H/BF-WT-3678</b>	36	78	1 <sup>1</sup> / <sub>4</sub>	3050	2.1	91
<b>H/BF-WT-3684</b>	36	84	1 <sup>1</sup> / <sub>4</sub>	3250	2.3	99

Specify Model Number, Wood Finish, and Optional Accessories

## Rectangular Straight Work Tops

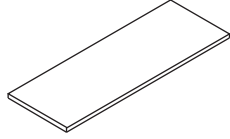

Model No.	Depth	Width	Height	Price	Cubic Feet	Weight
<b>H/RS-WT-2036</b>	20	36	1 <sup>1</sup> / <sub>4</sub>	925	0.6	25
<b>H/RS-WT-2042</b>	20	42	1 <sup>1</sup> / <sub>4</sub>	950	0.7	30
<b>H/RS-WT-2048</b>	20	48	1 <sup>1</sup> / <sub>4</sub>	975	0.8	35
<b>H/RS-WT-2054</b>	20	54	1 <sup>1</sup> / <sub>4</sub>	1000	0.9	40
<b>H/RS-WT-2060</b>	20	60	1 <sup>1</sup> / <sub>4</sub>	1000	1.0	45
<b>H/RS-WT-2066</b>	20	66	1 <sup>1</sup> / <sub>4</sub>	1050	1.1	50
<b>H/RS-WT-2072</b>	20	72	1 <sup>1</sup> / <sub>4</sub>	1175	1.2	55
<b>H/RS-WT-2078</b>	20	78	1 <sup>1</sup> / <sub>4</sub>	1250	1.3	60
<b>H/RS-WT-2084</b>	20	84	1 <sup>1</sup> / <sub>4</sub>	1375	1.4	65
<b>H/RS-WT-2090</b>	20	90	1 <sup>1</sup> / <sub>4</sub>	1550	1.5	70
<b>H/RS-WT-2096</b>	20	96	1 <sup>1</sup> / <sub>4</sub>	1675	1.6	75
<b>H/RS-WT-20108</b>	20	108	1 <sup>1</sup> / <sub>4</sub>	1950	1.8	85
<b>H/RS-WT-2436</b>	24	36	1 <sup>1</sup> / <sub>4</sub>	1075	0.7	30
<b>H/RS-WT-2442</b>	24	42	1 <sup>1</sup> / <sub>4</sub>	1125	0.8	35
<b>H/RS-WT-2448</b>	24	48	1 <sup>1</sup> / <sub>4</sub>	1175	0.9	40
<b>H/RS-WT-2454</b>	24	54	1 <sup>1</sup> / <sub>4</sub>	1175	1.0	45
<b>H/RS-WT-2460</b>	24	60	1 <sup>1</sup> / <sub>4</sub>	1200	1.1	50
<b>H/RS-WT-2466</b>	24	66	1 <sup>1</sup> / <sub>4</sub>	1250	1.2	55
<b>H/RS-WT-2472</b>	24	72	1 <sup>1</sup> / <sub>4</sub>	1350	1.3	60
<b>H/RS-WT-2478</b>	24	78	1 <sup>1</sup> / <sub>4</sub>	1475	1.4	65
<b>H/RS-WT-2484</b>	24	84	1 <sup>1</sup> / <sub>4</sub>	1625	1.5	70
<b>H/RS-WT-2490</b>	24	90	1 <sup>1</sup> / <sub>4</sub>	1800	1.6	75
<b>H/RS-WT-2496</b>	24	96	1 <sup>1</sup> / <sub>4</sub>	1950	1.7	80
<b>H/RS-WT-24108</b>	24	108	1 <sup>1</sup> / <sub>4</sub>	2300	1.9	90

Specify Model Number, Wood Finish, and Optional Accessories

Bubble Bow Work Top

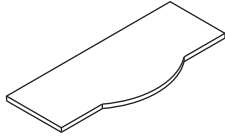

Model No.	Depth	Width	Height	Price	Dimension - A	Cubic Feet	Weight
<b>H/BB-WT-2436</b>	20/24	36	1 <sup>1</sup> / <sub>4</sub>	1075	9	0.6	25
<b>H/BB-WT-2442</b>	20/24	42	1 <sup>1</sup> / <sub>4</sub>	1100	10 <sup>1</sup> / <sub>2</sub>	0.7	30
<b>H/BB-WT-2448</b>	20/24	48	1 <sup>1</sup> / <sub>4</sub>	1125	12	0.8	35
<b>H/BB-WT-2454</b>	20/24	54	1 <sup>1</sup> / <sub>4</sub>	1175	13 <sup>1</sup> / <sub>2</sub>	0.9	40
<b>H/BB-WT-2460</b>	20/24	60	1 <sup>1</sup> / <sub>4</sub>	1200	15	1.0	45
<b>H/BB-WT-2466</b>	20/24	66	1 <sup>1</sup> / <sub>4</sub>	1225	16 <sup>1</sup> / <sub>2</sub>	1.1	50
<b>H/BB-WT-2472</b>	20/24	72	1 <sup>1</sup> / <sub>4</sub>	1325	18	1.2	55
<b>H/BB-WT-2478</b>	20/24	78	1 <sup>1</sup> / <sub>4</sub>	1450	19 <sup>1</sup> / <sub>2</sub>	1.3	60
<b>H/BB-WT-2484</b>	20/24	84	1 <sup>1</sup> / <sub>4</sub>	1600	21	1.4	65
<b>H/BB-WT-2490</b>	20/24	90	1 <sup>1</sup> / <sub>4</sub>	1750	22 <sup>1</sup> / <sub>2</sub>	1.5	70
<b>H/BB-WT-2496</b>	20/24	96	1 <sup>1</sup> / <sub>4</sub>	1925	24	1.6	75
<b>H/BB-WT-24108</b>	20/24	108	1 <sup>1</sup> / <sub>4</sub>	2225	27	1.8	85
<b>H/BB-WT-2836</b>	24/28	36	1 <sup>1</sup> / <sub>4</sub>	1250	9	0.7	30
<b>H/BB-WT-2842</b>	24/28	42	1 <sup>1</sup> / <sub>4</sub>	1300	10 <sup>1</sup> / <sub>2</sub>	0.8	35
<b>H/BB-WT-2848</b>	24/28	48	1 <sup>1</sup> / <sub>4</sub>	1325	12	0.9	40
<b>H/BB-WT-2854</b>	24/28	54	1 <sup>1</sup> / <sub>4</sub>	1350	13 <sup>1</sup> / <sub>2</sub>	1.0	45
<b>H/BB-WT-2860</b>	24/28	60	1 <sup>1</sup> / <sub>4</sub>	1375	15	1.1	50
<b>H/BB-WT-2866</b>	24/28	66	1 <sup>1</sup> / <sub>4</sub>	1425	16 <sup>1</sup> / <sub>2</sub>	1.2	55
<b>H/BB-WT-2872</b>	24/28	72	1 <sup>1</sup> / <sub>4</sub>	1575	18	1.3	60
<b>H/BB-WT-2878</b>	24/28	78	1 <sup>1</sup> / <sub>4</sub>	1700	19 <sup>1</sup> / <sub>2</sub>	1.4	65
<b>H/BB-WT-2884</b>	24/28	84	1 <sup>1</sup> / <sub>4</sub>	1875	21	1.5	70
<b>H/BB-WT-2890</b>	24/28	90	1 <sup>1</sup> / <sub>4</sub>	2075	22 <sup>1</sup> / <sub>2</sub>	1.6	75
<b>H/BB-WT-2896</b>	24/28	96	1 <sup>1</sup> / <sub>4</sub>	2250	24	1.7	80
<b>H/BB-WT-28108</b>	24/28	108	1 <sup>1</sup> / <sub>4</sub>	2625	27	1.9	90

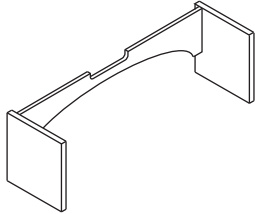

Specify Model Number, Wood Finish, and Optional Accessories

Auxiliary Top Support



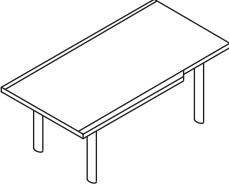

Model No.	Depth	Width	Height	Price	Cubic Feet	Weight
<b>H/ATS-2036</b>	19 <sup>1</sup> / <sub>4</sub>	36	27 <sup>3</sup> / <sub>4</sub>	1050	1.1	36
<b>H/ATS-2042</b>	19 <sup>1</sup> / <sub>4</sub>	42	27 <sup>3</sup> / <sub>4</sub>	1075	1.0	35
<b>H/ATS-2048</b>	19 <sup>1</sup> / <sub>4</sub>	48	27 <sup>3</sup> / <sub>4</sub>	1100	1.1	36
<b>H/ATS-2054</b>	19 <sup>1</sup> / <sub>4</sub>	54	27 <sup>3</sup> / <sub>4</sub>	1100	1.2	37
<b>H/ATS-2060</b>	19 <sup>1</sup> / <sub>4</sub>	60	27 <sup>3</sup> / <sub>4</sub>	1125	1.3	38
<b>H/ATS-2066</b>	19 <sup>1</sup> / <sub>4</sub>	66	27 <sup>3</sup> / <sub>4</sub>	1150	1.4	39
<b>H/ATS-2072</b>	19 <sup>1</sup> / <sub>4</sub>	72	27 <sup>3</sup> / <sub>4</sub>	1175	1.5	40
<b>H/ATS-2078</b>	19 <sup>1</sup> / <sub>4</sub>	78	27 <sup>3</sup> / <sub>4</sub>	1200	1.6	41
<b>H/ATS-2084</b>	19 <sup>1</sup> / <sub>4</sub>	84	27 <sup>3</sup> / <sub>4</sub>	1225	1.7	42
<b>H/ATS-2090</b>	19 <sup>1</sup> / <sub>4</sub>	90	27 <sup>3</sup> / <sub>4</sub>	1250	1.8	43
<b>H/ATS-2096</b>	19 <sup>1</sup> / <sub>4</sub>	96	27 <sup>3</sup> / <sub>4</sub>	1300	1.9	44
<b>H/ATS-20108</b>	19 <sup>1</sup> / <sub>4</sub>	108	27 <sup>3</sup> / <sub>4</sub>	1325	2.1	46
<b>H/ATS-2436</b>	23 <sup>1</sup> / <sub>4</sub>	36	27 <sup>3</sup> / <sub>4</sub>	1075	1.1	36
<b>H/ATS-2442</b>	23 <sup>1</sup> / <sub>4</sub>	42	27 <sup>3</sup> / <sub>4</sub>	1100	1.0	35
<b>H/ATS-2448</b>	23 <sup>1</sup> / <sub>4</sub>	48	27 <sup>3</sup> / <sub>4</sub>	1125	1.1	36
<b>H/ATS-2454</b>	23 <sup>1</sup> / <sub>4</sub>	54	27 <sup>3</sup> / <sub>4</sub>	1150	1.2	37
<b>H/ATS-2460</b>	23 <sup>1</sup> / <sub>4</sub>	60	27 <sup>3</sup> / <sub>4</sub>	1175	1.3	38
<b>H/ATS-2466</b>	23 <sup>1</sup> / <sub>4</sub>	66	27 <sup>3</sup> / <sub>4</sub>	1200	1.4	39
<b>H/ATS-2472</b>	23 <sup>1</sup> / <sub>4</sub>	72	27 <sup>3</sup> / <sub>4</sub>	1225	1.5	40
<b>H/ATS-2478</b>	23 <sup>1</sup> / <sub>4</sub>	78	27 <sup>3</sup> / <sub>4</sub>	1225	1.6	41
<b>H/ATS-2484</b>	23 <sup>1</sup> / <sub>4</sub>	84	27 <sup>3</sup> / <sub>4</sub>	1250	1.7	42
<b>H/ATS-2490</b>	23 <sup>1</sup> / <sub>4</sub>	90	27 <sup>3</sup> / <sub>4</sub>	1275	1.8	43
<b>H/ATS-2496</b>	23 <sup>1</sup> / <sub>4</sub>	96	27 <sup>3</sup> / <sub>4</sub>	1325	1.9	44
<b>H/ATS-24108</b>	23 <sup>1</sup> / <sub>4</sub>	108	27 <sup>3</sup> / <sub>4</sub>	1350	2.1	46

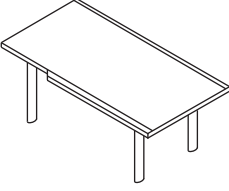
Specify Model Number, Wood Finish, and Optional Accessories

	Model No.	Depth	Width	Height	Price	Cubic Feet	Weight
<b>Connecting Straight Front Desk Table</b>							
 (R)ight  	<b>H/CXSF-DT-3060</b>	30	60	29	3050	3.8	85
	<b>H/CXSF-DT-3066</b>	30	66	29	3225	4.0	90
	<b>H/CXSF-DT-3072</b>	30	72	29	3425	4.2	96
	<b>H/CXSF-DT-3078</b>	30	78	29	3625	4.4	102
	<b>H/CXSF-DT-3084</b>	30	84	29	3825	4.6	110
 (L)eft  	<b>H/CXSF-DT-3660</b>	36	60	29	3425	4.0	95
	<b>H/CXSF-DT-3666</b>	36	66	29	3700	4.2	103
	<b>H/CXSF-DT-3672</b>	36	72	29	3925	4.4	110
	<b>H/CXSF-DT-3678</b>	36	78	29	4125	4.6	116
	<b>H/CXSF-DT-3684</b>	36	84	29	4375	4.8	124

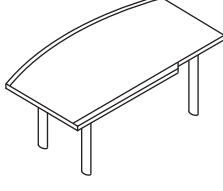
Use with Connecting Bridges and Returns

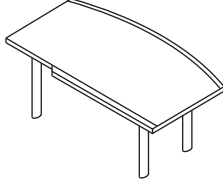
<b>Connecting Bow Front Desk Table</b>							
 (R)ight  	<b>H/CXBF-DT-3060</b>	30	60	29	3600	3.8	85
	<b>H/CXBF-DT-3066</b>	30	66	29	3800	4.0	90
	<b>H/CXBF-DT-3072</b>	30	72	29	3975	4.2	96
	<b>H/CXBF-DT-3078</b>	30	78	29	4200	4.4	102
	<b>H/CXBF-DT-3084</b>	30	84	29	4375	4.6	110
 (L)eft  	<b>H/CXBF-DT-3660</b>	36	60	29	3975	4.0	95
	<b>H/CXBF-DT-3666</b>	36	66	29	4250	4.2	103
	<b>H/CXBF-DT-3672</b>	36	72	29	4475	4.4	110
	<b>H/CXBF-DT-3678</b>	36	78	29	4700	4.6	116
	<b>H/CXBF-DT-3684</b>	36	84	29	4950	4.8	124

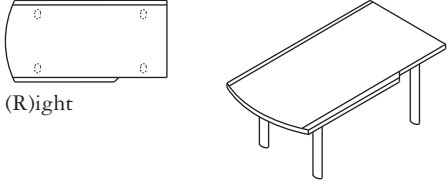
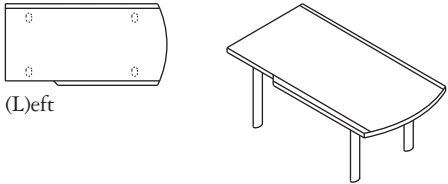

Use with Connecting Bridges and Returns

Specify Model Number and Handing, Wood Finish, and Optional Accessories  
 Example: H/CXBF-DT-3060-R (check line drawings to determine handing)

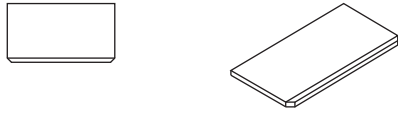

	Model No.	Depth	Width	Height	Price	Cubic Feet	Weight
<b>Connecting Radiused End Desk Table</b>							
 <p>(R)ight</p>	<b>H/CXRE-DT-3060</b>	30	60	29	3475	3.8	85
	<b>H/CXRE-DT-3066</b>	30	66	29	3725	4.0	90
	<b>H/CXRE-DT-3072</b>	30	72	29	3850	4.2	96
	<b>H/CXRE-DT-3078</b>	30	78	29	4225	4.4	102
	<b>H/CXRE-DT-3084</b>	30	84	29	4600	4.6	110
 <p>(L)eft</p>	<b>H/CXRE-DT-3660</b>	36	60	29	3975	4.0	95
	<b>H/CXRE-DT-3666</b>	36	66	29	4225	4.2	103
	<b>H/CXRE-DT-3672</b>	36	72	29	4475	4.4	110
	<b>H/CXRE-DT-3678</b>	36	78	29	4850	4.6	116
	<b>H/CXRE-DT-3684</b>	36	84	29	5225	4.8	124

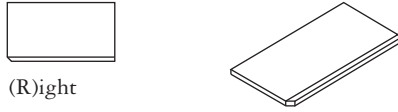
Use with Connecting Bridges and Returns

<b>Connecting Bridge Work Top</b>							
	<b>H/CXB-WT-2442</b>	24	42	1 <sup>1</sup> / <sub>4</sub>	1350	0.8	35
	<b>H/CXB-WT-2448</b>	24	48	1 <sup>1</sup> / <sub>4</sub>	1375	0.9	40
	<b>H/CXB-WT-2454</b>	24	54	1 <sup>1</sup> / <sub>4</sub>	1400	1.0	45
	<b>H/CXB-WT-2460</b>	24	60	1 <sup>1</sup> / <sub>4</sub>	1425	1.1	50

<b>Connecting Return Work Top</b>							
 <p>(R)ight</p>	<b>H/CXR-WT-2442</b>	24	42	1 <sup>1</sup> / <sub>4</sub>	1325	0.8	35
	<b>H/CXR-WT-2448</b>	24	48	1 <sup>1</sup> / <sub>4</sub>	1350	0.9	40
	<b>H/CXR-WT-2454</b>	24	54	1 <sup>1</sup> / <sub>4</sub>	1375	1.0	45
 <p>(L)eft</p>	<b>H/CXR-WT-2460</b>	24	60	1 <sup>1</sup> / <sub>4</sub>	1400	1.1	50
	<b>H/CXR-WT-2466</b>	24	66	1 <sup>1</sup> / <sub>4</sub>	1475	1.2	55
	<b>H/CXR-WT-2472</b>	24	72	1 <sup>1</sup> / <sub>4</sub>	1600	1.3	60

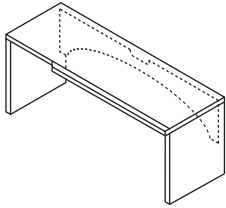
Specify Model Number and Handing, Wood Finish, and Optional Accessories  
 Example: H/CXRE-DT-3060-R (check line drawings to determine handing)

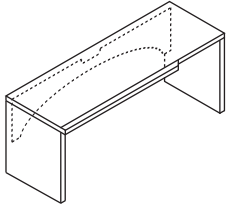
Connecting Rectangular Straight Auxiliary Table		Model No.	Depth	Width	Height	Price	Cubic Feet	Weight
 (R)ight		<b>H/CXRS-AT-2036</b>	20	36	29	2325	3.1	70
		<b>H/CXRS-AT-2042</b>	20	42	29	2400	3.2	77
 (L)eft		<b>H/CXRS-AT-2048</b>	20	48	29	2475	3.3	84
		<b>H/CXRS-AT-2054</b>	20	54	29	2525	3.4	91
		<b>H/CXRS-AT-2060</b>	20	60	29	2550	3.5	98
		<b>H/CXRS-AT-2066</b>	20	66	29	2625	3.6	105
		<b>H/CXRS-AT-2072</b>	20	72	29	2800	3.7	112
		<b>H/CXRS-AT-2078</b>	20	78	29	2950	3.8	119
		<b>H/CXRS-AT-2084</b>	20	84	29	3125	3.9	126
		<b>H/CXRS-AT-2090</b>	20	90	29	3350	4.0	133
		<b>H/CXRS-AT-2096</b>	20	96	29	3550	4.1	140
		<b>H/CXRS-AT-20108</b>	20	108	29	3925	4.3	147
		<b>H/CXRS-AT-2436</b>	24	36	29	2550	3.2	75
		<b>H/CXRS-AT-2442</b>	24	42	29	2675	3.2	82
		<b>H/CXRS-AT-2448</b>	24	48	29	2725	3.4	89
		<b>H/CXRS-AT-2454</b>	24	54	29	2750	3.5	96
		<b>H/CXRS-AT-2460</b>	24	60	29	2825	3.6	103
		<b>H/CXRS-AT-2466</b>	24	66	29	2925	3.7	110
		<b>H/CXRS-AT-2472</b>	24	72	29	3075	3.8	117
		<b>H/CXRS-AT-2478</b>	24	78	29	3250	3.9	124
		<b>H/CXRS-AT-2484</b>	24	84	29	3450	4.0	131
		<b>H/CXRS-AT-2490</b>	24	90	29	3675	4.1	138
		<b>H/CXRS-AT-2496</b>	24	96	29	3925	4.2	145
		<b>H/CXRS-AT-24108</b>	24	108	29	4375	4.4	152

Specify Model Number and Handing, Wood Finish, and Optional Accessories  
 Example: H/CXRS-AT-2460-R (check line drawings to determine handing)

	Model No.	Depth	Width	Height	Price	Cubic Feet	Weight
Connecting Rectangular Straight Work Top	<b>H/CXRS-WT-2036</b>	20	36	29	1100	3.1	70
	<b>H/CXRS-WT-2042</b>	20	42	29	1125	3.2	77
(R)ight	<b>H/CXRS-WT-2048</b>	20	48	29	1175	3.3	84
	<b>H/CXRS-WT-2054</b>	20	54	29	1200	3.4	91
(L)eft	<b>H/CXRS-WT-2060</b>	20	60	29	1200	3.5	98
	<b>H/CXRS-WT-2066</b>	20	66	29	1250	3.6	105
	<b>H/CXRS-WT-2072</b>	20	72	29	1400	3.7	112
	<b>H/CXRS-WT-2078</b>	20	78	29	1500	3.8	119
	<b>H/CXRS-WT-2084</b>	20	84	29	1650	3.9	126
	<b>H/CXRS-WT-2090</b>	20	90	29	1850	4.0	133
	<b>H/CXRS-WT-2096</b>	20	96	29	2000	4.1	140
	<b>H/CXRS-WT-2108</b>	20	108	29	2325	4.3	147
	<b>H/CXRS-WT-2436</b>	24	36	29	1275	3.2	75
	<b>H/CXRS-WT-2442</b>	24	42	29	1350	3.2	82
	<b>H/CXRS-WT-2448</b>	24	48	29	1400	3.4	89
	<b>H/CXRS-WT-2454</b>	24	54	29	1400	3.5	96
	<b>H/CXRS-WT-2460</b>	24	60	29	1425	3.6	103
	<b>H/CXRS-WT-2466</b>	24	66	29	1500	3.7	110
	<b>H/CXRS-WT-2472</b>	24	72	29	1625	3.8	117
	<b>H/CXRS-WT-2478</b>	24	78	29	1775	3.9	124
	<b>H/CXRS-WT-2484</b>	24	84	29	1950	4.0	131
	<b>H/CXRS-WT-2490</b>	24	90	29	2150	4.1	138
	<b>H/CXRS-WT-2496</b>	24	96	29	2325	4.2	145
	<b>H/CXRS-WT-24108</b>	24	108	29	2750	4.4	152

Specify Model Number and Handing, Wood Finish, and Optional Accessories  
 Example: H/CXRS-WT-2460-R (check line drawings to determine handing)

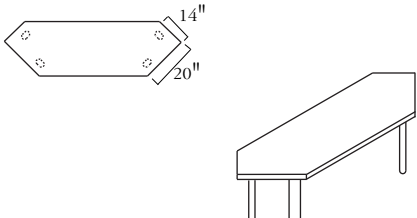
	Model No.	Depth	Width	Height	Price	Cubic Feet	Weight
<p>Hexagonal Auxiliary Table</p> 	<b>H/HAT-2463</b>	24	63	29	2475	6.8	100
	<b>H/HAT-2469</b>	24	69	29	2800	6.9	108
	<b>H/HAT-2475</b>	24	75	29	3100	7.0	116
	<b>H/HAT-2481</b>	24	81	29	3425	7.1	124
	<b>H/HAT-2487</b>	24	87	29	3725	7.2	132

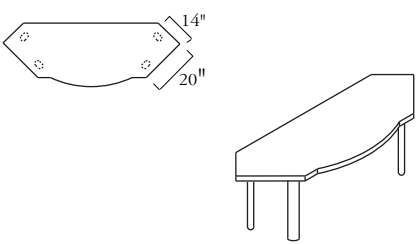
<p>Hexagonal Bow Auxiliary Table</p> 	<b>H/HBAT-2877</b>	28	77	29	2625	7.6	96
	<b>H/HBAT-2889</b>	28	89	29	2950	7.7	104
	<b>H/HBAT-28101</b>	28	101	29	3250	7.8	112

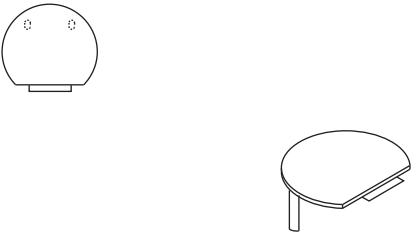
<p>Dome Junction Top</p> 	<b>H/DJT-3042</b>	36	42	29	2050	2.3	65
	<b>H/DJT-3648</b>	40	48	29	2200	3.3	75

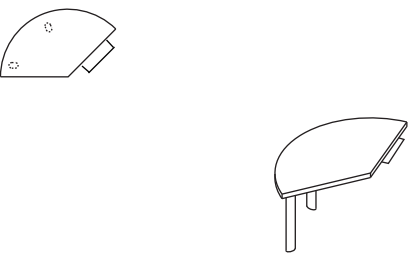
<p>Pie Junction Top</p> 	<b>H/PJT-3030</b>	30	55	29	2200	2.3	70
	<b>H/PJT-3636</b>	36	66	29	2350	2.5	80

•Handing is configured on-site

Specify Model Number, Wood Finish, and Optional Accessories

	Model No.	Depth	Width	Height	Price	Cubic Feet	Weight
Triangular Junction Top 	<b>H/TJT-2424</b>	17	40	1 1/4	1000	0.5	25
	<b>H/TJT-3030</b>	21	48	1 1/4	1175	0.8	33
	<b>H/TJT-3636</b>	25	56	1 1/4	1325	1.0	45

Wedge Junction Top 	<b>H/WJT-2424</b>	25	39	1 1/4	1175	0.8	33
	<b>H/WJT-3030</b>	31	48	1 1/4	1325	1.1	50
	<b>H/WJT-3636</b>	37	56	1 1/4	1475	1.5	68

Column Leg Tall Stationary	<b>H/CLTS-2429</b>	2	4	27 <sup>3</sup> / <sub>4</sub>	225	1.3	6.0
Column Leg Tall Mobile	<b>H/CLTM-2429</b>	2	4	27 <sup>3</sup> / <sub>4</sub>	250	1.3	6.5

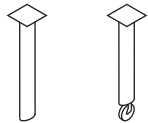

Column Leg Short Stationary	<b>H/CLSS-2427</b>	2	4	25	225	1.3	6.0
Column Leg Short Mobile	<b>H/CLSM-2427</b>	2	4	25	250	1.3	6.5

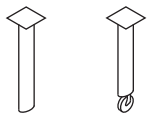

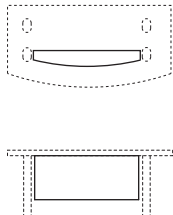
Modesty Panel 	<b>H/MP-1648</b>	6	48	16	950	3.0	10
	<b>H/MP-1654</b>	6	54	16	1075	3.3	13
	<b>H/MP-1660</b>	6	60	16	1175	3.5	16
	<b>H/MP-1666</b>	6	66	16	1300	3.8	19
	<b>H/MP-1672</b>	6	72	16	1425	4.0	24

Specify Model Number, Wood Finish, and Optional Accessories

20" Deep Pedestals

	Model No.	Depth	Width	Height	Price	Cubic Feet	Weight
Mobile Pedestal - Two File Drawer	<b>H/MOB-A-2018</b>	20	18	27	2200	6.0	45
Mobile Pedestal - Two Box and File Drawer	<b>H/MOB-B-2018</b>	20	18	27	2200	6.0	52

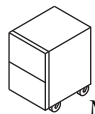

MOB-A

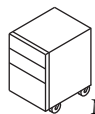

MOB-B

Worktop Pedestals

Two File Drawers	<b>H/L-A-2018</b>	20	18	28	1575	7.0	48
Two Box and File Drawers	<b>H/L-B-2018</b>	20	18	28	1575	7.0	55

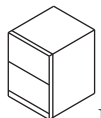

L-A



L-B

Two Lateral File Drawers	<b>H/L-M-2030</b>	20	30	28	1875	12.0	61
Two Lateral File Drawers	<b>H/L-K-2036</b>	20	36	28	2200	14.5	73

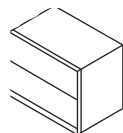

L-M

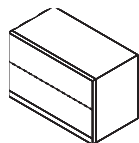

L-K

Swing Door Storage	<b>H/L-H-2018(L or R)</b>	20	18	28	1100	7.0	44
Double Swing Door Storage	<b>H/L-P-2030</b>	20	30	28	1250	12.0	55
Double Swing Door Storage	<b>H/L-J-2036</b>	20	36	28	1425	14.5	66

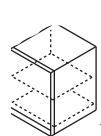

L-H

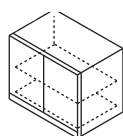

L-P

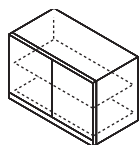

L-J

•On L-H Pedestals, Specify: (R)ight if hinge is on the right  
(L)eft if hinge is on the left

CPU Storage	<b>H/L-CPU-O</b>	20	12	28	925	4.8	40
	Inside Dimensions	18	10	23			
CPU Storage with Pocket Door	<b>H/L-CPU-D</b>	20	12	28	1250	4.8	43
	Inside Dimensions	18	9	23			

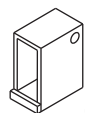

CPU-O

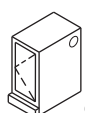

CPU-D

•For Pull-out shelf Add 150

Worktop pedestals are finished on all sides except top.  
To be used under worktops

Specify Model Number, Wood Finish, and Optional Accessories

24" Deep Pedestals

Mobile Pedestal - Two File Drawer

Model No.	Depth	Width	Height	Price	Cubic Feet	Weight
-----------	-------	-------	--------	-------	------------	--------

<b>H/MOB-A-2418</b>	24	18	27	2350	6.0	45
---------------------	----	----	----	------	-----	----

Mobile Pedestal - Two Box and File Drawer

<b>H/MOB-B-2418</b>	24	18	27	2350	6.0	52
---------------------	----	----	----	------	-----	----

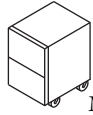

MOB-A

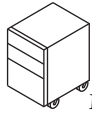

MOB-B

Worktop Pedestals

Two File Drawers

<b>H/L-A-2418</b>	24	18	28	1725	7.0	48
-------------------	----	----	----	------	-----	----

Two Box and File Drawers

<b>H/L-B-2418</b>	24	18	28	1725	7.0	55
-------------------	----	----	----	------	-----	----

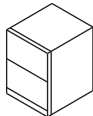

L-A



L-B

Two Lateral File Drawers

<b>H/L-M-2430</b>	24	30	28	2050	12.0	61
-------------------	----	----	----	------	------	----

Two Lateral File Drawers

<b>H/L-K-2436</b>	24	36	28	2200	14.5	73
-------------------	----	----	----	------	------	----

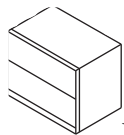

L-M

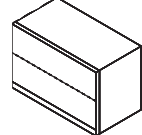

L-K

Swing Door Storage

<b>H/L-H-2418( L or R)</b>	24	18	28	1250	7.0	44
----------------------------	----	----	----	------	-----	----

Double Swing Door Storage

<b>H/L-P-2430</b>	24	30	28	1425	12.0	55
-------------------	----	----	----	------	------	----

Double Swing Door Storage

<b>H/L-J-2436</b>	24	36	28	1575	14.5	66
-------------------	----	----	----	------	------	----

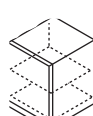

L-H

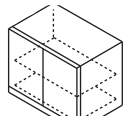

L-P

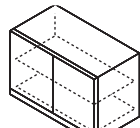

L-J

•On L-H Pedestals, Specify: (R)ight if hinge is on the right  
(L)eft if hinge is on the left

CPU Storage

<b>H/L-CPU-O</b>	24	12	28	1075	4.8	40
Inside Dimensions	22	10	23			

CPU Storage with Pocket Door

<b>H/L-CPU-D</b>	24	12	28	1425	4.8	43
Inside Dimensions	22	9	23			

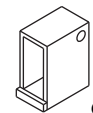

CPU-O

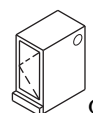

CPU-D

•For Pull-out shelf Add 150

Worktop pedestals are finished on all sides except top.  
To be used under worktops

Specify Model Number, Wood Finish, and Optional Accessories

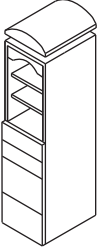
	Model No.	Depth	Width	Height	Price	Cubic Feet	Weight
Tower Open w/Black Cupola	<b>H/TOC-1878-1-20</b>	20	18	78	4800	17	150
	<b>H/TOC-1878-1-24</b>	24	18	78	5175	17	150

•For Glass Shelves Add 75

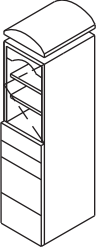
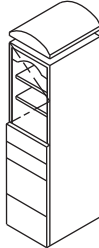
Tower Glass Door w/Black Cupola	<b>H/TGC-1878-1-(L or R)-20</b>	20	18	78	5300	17	155
 	<b>H/TGC-1878-1-(L or R)-24</b>	24	18	78	5675	17	155

•Specify: (R)ight if hinge is on the right  
(L)eft if hinge is on the left  
•For Glass Shelves Add 75

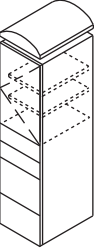
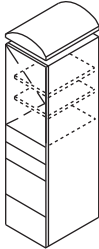
Tower Wood Door w/Black Cupola	<b>H/TWC-1878-1-(L or R)-20</b>	20	18	78	4975	17	165
 	<b>H/TWC-1878-1-(L or R)-24</b>	24	18	78	5350	17	165

•Specify: (R)ight if hinge is on the right  
(L)eft if hinge is on the left

Specify Model Number, Wood Finish, and Optional Accessories

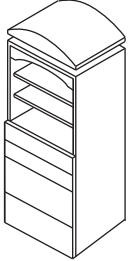
	Model No.	Depth	Width	Height	Price	Cubic Feet	Weight
Tower Open w/Black Cupola 	<b>H/TOC-3078-1-20</b>	20	30	78	5600	27	185
	<b>H/TOC-3678-1-20</b>	20	36	78	6550	27	180
	<b>H/TOC-3078-1-24</b>	24	30	78	6100	27	185
	<b>H/TOC-3678-1-24</b>	24	36	78	7050	27	180
•For Glass Shelves Add 150							

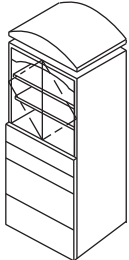
Tower Glass Door w/Black Cupola 	<b>H/TGC-3078-1-20</b>	20	30	78	6700	27	190
	<b>H/TGC-3678-1-20</b>	20	36	78	7600	27	180
	<b>H/TGC-3078-1-24</b>	24	30	78	7200	27	190
	<b>H/TGC-3678-1-24</b>	24	36	78	8100	27	180
•For Glass Shelves Add 150							

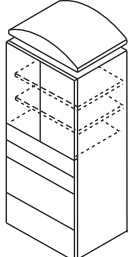
Tower Wood Door w/Black Cupola 	<b>H/TWC-3078-1-20</b>	20	30	78	6225	27	200
	<b>H/TWC-3678-1-20</b>	20	36	78	7175	27	180
	<b>H/TWC-3078-1-24</b>	24	30	78	6725	27	200
	<b>H/TWC-3678-1-24</b>	24	36	78	7675	27	180

Specify Model Number, Wood Finish, and Optional Accessories

Model No.	Depth	Width	Height	Price	Cubic Feet	Weight
<b>Tower Open w/Black Cupola</b>						
<b>H/TOC-1878-2-(L or R)-20</b>	20	18	78	4475	17	145
<b>H/TOC-1878-2-(L or R)-24</b>	24	18	78	4850	17	145

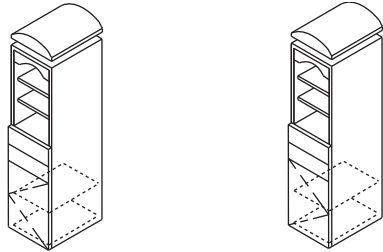

- Specify: (R)ight if hinge is on the right  
(L)eft if hinge is on the left
- For Glass Shelves Add 75

<b>Tower Glass Door w/Black Cupola</b>						
<b>H/TGC-1878-2-(L or R)-20</b>	20	18	78	4975	17	150
<b>H/TGC-1878-2-(L or R)-24</b>	24	18	78	5350	17	150

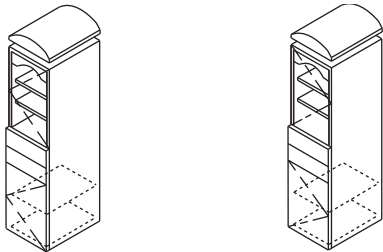

- Specify: (R)ight if hinge is on the right  
(L)eft if hinge is on the left
- For Glass Shelves Add 75

<b>Tower Wood Door w/Black Cupola</b>						
<b>H/TWC-1878-2-(L or R)-20</b>	20	18	78	4675	17	160
<b>H/TWC-1878-2-(L or R)-24</b>	24	18	78	5050	17	160

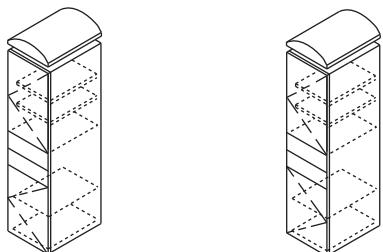

- Specify: (R)ight if hinge is on the right  
(L)eft if hinge is on the left

Specify Model Number, Wood Finish, and Optional Accessories

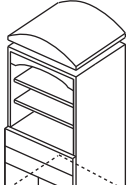
	Model No.	Depth	Width	Height	Price	Cubic Feet	Weight
Tower Open w/Black Cupola 	<b>H/TOC-3078-2-20</b>	20	30	78	5125	27	180
	<b>H/TOC-3678-2-20</b>	20	36	78	6075	27	180
	<b>H/TOC-3078-2-24</b>	24	30	78	5625	27	180
	<b>H/TOC-3678-2-24</b>	24	36	78	6575	27	180

•For Glass Shelves Add 150

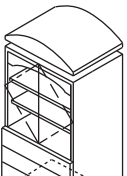
Tower Glass Door w/Black Cupola 	<b>H/TGC-3078-2-20</b>	20	30	78	6225	27	185
	<b>H/TGC-3678-2-20</b>	20	36	78	7175	27	180
	<b>H/TGC-3078-2-24</b>	24	30	78	6725	27	185
	<b>H/TGC-3678-2-24</b>	24	36	78	7675	27	180

•For Glass Shelves Add 150

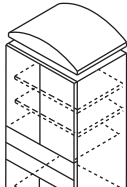
Tower Wood Door w/Black Cupola 	<b>H/TWC-3078-2-20</b>	20	30	78	5750	27	195
	<b>H/TWC-3678-2-20</b>	20	36	78	6700	27	180
	<b>H/TWC-3078-2-24</b>	24	30	78	6250	27	195
	<b>H/TWC-3678-2-24</b>	24	36	78	7200	27	180

Specify Model Number, Wood Finish, and Optional Accessories

Model No.	Depth	Width	Height	Price	Cubic Feet	Weight
Tower Open w/Black Cupola						
<b>H/TOC-1878-3-20</b>	20	18	78	5100	17	160

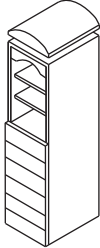

<b>H/TOC-1878-3-24</b>	24	18	78	5475	17	160
------------------------	----	----	----	------	----	-----

•For Glass Shelves Add 75

Tower Glass Door w/Black Cupola

<b>H/TGC-1878-3-(L or R)-20</b>	20	18	78	5600	17	165
---------------------------------	----	----	----	------	----	-----

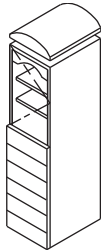
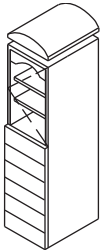

<b>H/TGC-1878-3-(L or R)-24</b>	24	18	78	5975	17	165
---------------------------------	----	----	----	------	----	-----

•Specify: (R)ight if hinge is on the right  
(L)eft if hinge is on the left

•For Glass Shelves Add 75

Tower Wood Door w/Black Cupola

<b>H/TWC-1878-3-(L or R)-20</b>	20	18	78	5300	17	175
---------------------------------	----	----	----	------	----	-----

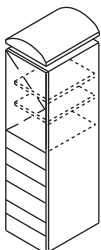
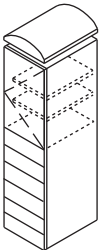

<b>H/TWC-1878-3-(L or R)-24</b>	24	18	78	5675	17	175
---------------------------------	----	----	----	------	----	-----

•Specify: (R)ight if hinge is on the right  
(L)eft if hinge is on the left

Specify Model Number, Wood Finish, and Optional Accessories

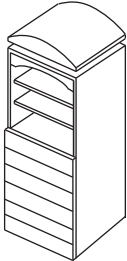
	Model No.	Depth	Width	Height	Price	Cubic Feet	Weight
Tower Open w/Black Cupola 	<b>H/TOC-3078-3-20</b>	20	30	78	5925	27	200
	<b>H/TOC-3678-3-20</b>	20	36	78	6850	27	180
	<b>H/TOC-3078-3-24</b>	24	30	78	6425	27	200
	<b>H/TOC-3678-3-24</b>	24	36	78	7350	27	180
•For Glass Shelves Add 150							

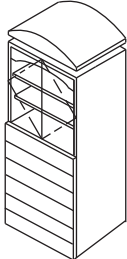
Tower Glass Door w/Black Cupola 	<b>H/TGC-3078-3-20</b>	20	30	78	7000	27	210
	<b>H/TGC-3678-3-20</b>	20	36	78	7925	27	180
	<b>H/TGC-3078-3-24</b>	24	30	78	7500	27	210
	<b>H/TGC-3678-3-24</b>	24	36	78	8425	27	180
•For Glass Shelves Add 150							

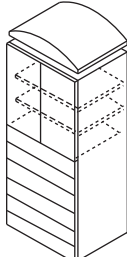
Tower Wood Door w/Black Cupola 	<b>H/TWC-3078-3-20</b>	20	30	78	6700	27	220
	<b>H/TWC-3678-3-20</b>	20	36	78	7600	27	180
	<b>H/TWC-3078-3-24</b>	24	30	78	7200	27	220
	<b>H/TWC-3678-3-24</b>	24	36	78	8100	27	180

Specify Model Number, Wood Finish, and Optional Accessories

Model No.	Depth	Width	Height	Price	Cubic Feet	Weight
Tower Open w/Black Cupola						
<b>H/TOC-1878-4-20</b>	20	18	78	4050	17	150

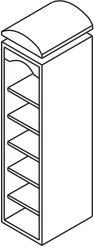

<b>H/TOC-1878-4-24</b>	24	18	78	4425	17	150
------------------------	----	----	----	------	----	-----

•For Glass Shelves Add 175

Tower Glass Door w/Black Cupola

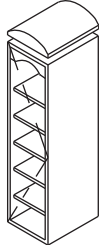
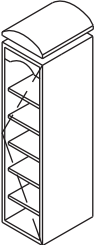

<b>H/TGC-1878-4-(L or R)-20</b>	20	18	78	4675	17	135
---------------------------------	----	----	----	------	----	-----

<b>H/TGC-1878-4-(L or R)-24</b>	24	18	78	5050	17	135
---------------------------------	----	----	----	------	----	-----

•Specify: (R)ight if hinge is on the right  
(L)eft if hinge is on the left

•For Glass Shelves Add 175

Tower Wood Door w/Black Cupola

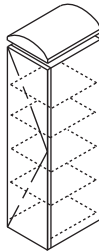
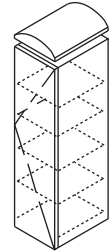

<b>H/TWC-1878-4-(L or R)-20</b>	20	18	78	4350	17	175
---------------------------------	----	----	----	------	----	-----

<b>H/TWC-1878-4-(L or R)-24</b>	24	18	78	4725	17	175
---------------------------------	----	----	----	------	----	-----

•Specify: (R)ight if hinge is on the right  
(L)eft if hinge is on the left

Tower Electronic Storage w/Black Cupola

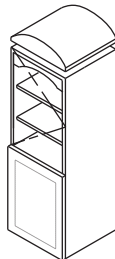
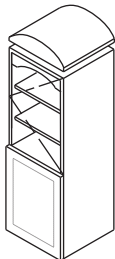

<b>H/TEC-2478-5-(L or R)-20</b>	20	24	78	4825	26	200
---------------------------------	----	----	----	------	----	-----

<b>H/TEC-2478-5-(L or R)-24</b>	24	24	78	5200	26	200
---------------------------------	----	----	----	------	----	-----

•Specify: (R)ight if hinge is on the right  
(L)eft if hinge is on the left

•For Glass Shelves Add 75

Specify Model Number, Wood Finish, and Optional Accessories

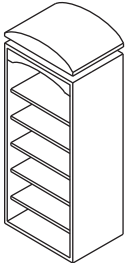
	Model No.	Depth	Width	Height	Price	Cubic Feet	Weight
Tower Open w/Black Cupola 	<b>H/TOC-3078-4-20</b>	20	30	78	4675	27	155
	<b>H/TOC-3678-4-20</b>	20	36	78	5600	27	180
	<b>H/TOC-3078-4-24</b>	24	30	78	5175	27	155
	<b>H/TOC-3678-4-24</b>	24	36	78	6100	27	180
	•For Glass Shelves Add 225						

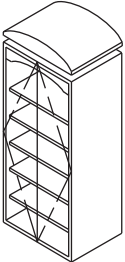
Tower Glass Door w/Black Cupola 	<b>H/TGC-3078-4-20</b>	20	30	78	5600	27	185
	<b>H/TGC-3678-4-20</b>	20	36	78	6550	27	180
	<b>H/TGC-3078-4-24</b>	24	30	78	6100	27	185
	<b>H/TGC-3678-4-24</b>	24	36	78	7050	27	180
	•For Glass Shelves Add 225						

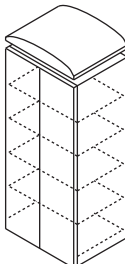
Tower Wood Door w/Black Cupola 	<b>H/TWC-3078-4-20</b>	20	30	78	5300	27	200
	<b>H/TWC-3678-4-20</b>	20	36	78	6225	27	180
	<b>H/TWC-3078-4-24</b>	24	30	78	5800	27	200
	<b>H/TWC-3678-4-24</b>	24	36	78	6725	27	180

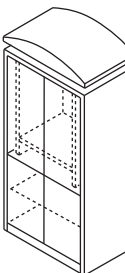
Tower Audio Visual Unit w/Black Cupola 	<b>H/TAVC-3678-6</b>	24	36	78	7450	39	275
---	----------------------	----	----	----	------	----	-----

Specify Model Number, Wood Finish, and Optional Accessories

	Model No.	Depth	Width	Height	Price	Cubic Feet	Weight
Tower Open	<b>H/TO-1872-1-20</b>	20	18	72	4175	17	150
	<b>H/TO-1872-1-24</b>	24	18	72	4550	17	150
<ul style="list-style-type: none"> <li>•For Glass Shelves Add 75</li> </ul>							

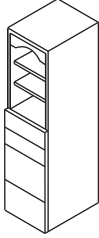

Tower Glass Door

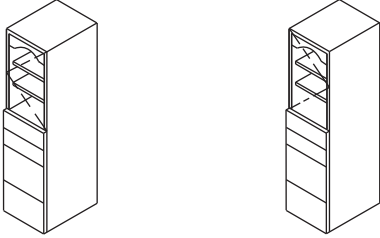

	<b>H/TG-1872-1-(L or R)-20</b>	20	18	72	4675	17	155
	<b>H/TG-1872-1-(L or R)-24</b>	24	18	72	5050	17	155
<ul style="list-style-type: none"> <li>•Specify: (R)ight if hinge is on the right (L)eft if hinge is on the left</li> <li>•For Glass Shelves Add 75</li> </ul>							

Tower Wood Door

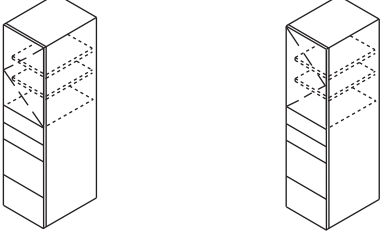

	<b>H/TW-1872-1-(L or R)-20</b>	20	18	72	4350	17	165
	<b>H/TW-1872-1-(L or R)-24</b>	24	18	72	4725	17	165
<ul style="list-style-type: none"> <li>•Specify: (R)ight if hinge is on the right (L)eft if hinge is on the left</li> </ul>							

Specify Model Number, Wood Finish, and Optional Accessories

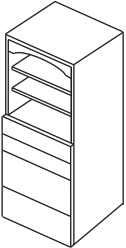
	Model No.	Depth	Width	Height	Price	Cubic Feet	Weight
Tower Open 	<b>H/TO-3078-1-20</b>	20	30	78	4825	27	185
	<b>H/TO-3678-1-20</b>	20	36	78	5450	27	180
	<b>H/TO-3078-1-24</b>	24	30	78	5325	27	185
	<b>H/TO-3678-1-24</b>	24	36	78	5950	27	180
•For Glass Shelves Add 150							

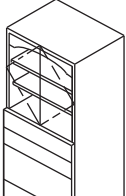
Tower Glass Door 	<b>H/TG-3078-1-20</b>	20	30	78	5925	27	190
	<b>H/TG-3678-1-20</b>	20	36	78	6550	27	180
	<b>H/TG-3078-1-24</b>	24	30	78	6425	27	190
	<b>H/TG-3678-1-24</b>	24	36	78	7050	27	180
•For Glass Shelves Add 150							

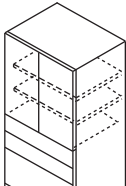
Tower Wood Door 	<b>H/TW-3078-1-20</b>	20	30	78	5450	27	200
	<b>H/TW-3678-1-20</b>	20	36	78	6075	27	180
	<b>H/TW-3078-1-24</b>	24	30	78	5950	27	200
	<b>H/TW-3678-1-24</b>	24	36	78	6575	27	180

Specify Model Number, Wood Finish, and Optional Accessories

	Model No.	Depth	Width	Height	Price	Cubic Feet	Weight
Tower Open	<b>H/TO-1872-2-(L or R)-20</b>	20	18	72	3850	17	145
	<b>H/TO-1872-2-(L or R)-24</b>	24	18	72	4225	17	145

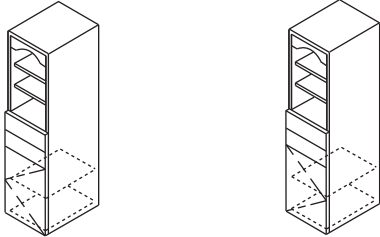

- Specify: (R)ight if hinge is on the right  
(L)eft if hinge is on the left
- For Glass Shelves Add 75

Tower Glass Door	<b>H/TG-1872-2-(L or R)-20</b>	20	18	72	4350	17	150
	<b>H/TG-1872-2-(L or R)-24</b>	24	18	72	4725	17	150

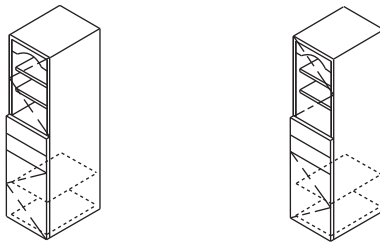

- Specify: (R)ight if hinge is on the right  
(L)eft if hinge is on the left
- For Glass Shelves Add 75

Tower Wood Door	<b>H/TW-1872-2-(L or R)-20</b>	20	18	72	4050	17	160
	<b>H/TW-1872-2-(L or R)-24</b>	24	18	72	4425	17	160

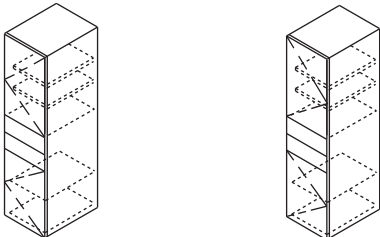

- Specify: (R)ight if hinge is on the right  
(L)eft if hinge is on the left

Specify Model Number, Wood Finish, and Optional Accessories

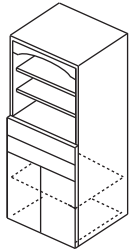
	Model No.	Depth	Width	Height	Price	Cubic Feet	Weight
Tower Open 	<b>H/TO-3072-2-20</b>	20	30	72	4350	27	180
	<b>H/TO-3672-2-20</b>	20	36	72	4975	27	180
	<b>H/TO-3072-2-24</b>	24	30	72	4850	27	180
	<b>H/TO-3672-2-24</b>	24	36	72	5475	27	180
•For Glass Shelves Add 150							

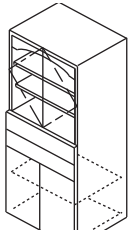
Tower Glass Door 	<b>H/TG-3072-2-20</b>	20	30	72	5450	27	185
	<b>H/TG-3672-2-20</b>	20	36	72	6075	27	180
	<b>H/TG-3072-2-24</b>	24	30	72	5950	27	185
	<b>H/TG-3672-2-24</b>	24	36	72	6575	27	180
•For Glass Shelves Add 150							

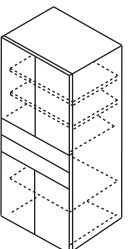
Tower Wood Door 	<b>H/TW-3072-2-20</b>	20	30	72	4975	27	195
	<b>H/TW-3672-2-20</b>	20	36	72	5600	27	180
	<b>H/TW-3072-2-24</b>	24	30	72	5475	27	195
	<b>H/TW-3672-2-24</b>	24	36	72	6100	27	180

Specify Model Number, Wood Finish, and Optional Accessories

	Model No.	Depth	Width	Height	Price	Cubic Feet	Weight
Tower Open	<b>H/TO-1872-3-20</b>	20	18	72	4475	17	160
	<b>H/TO-1872-3-24</b>	24	18	72	4850	17	160

•For Glass Shelves Add 75

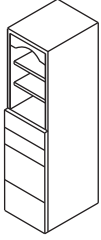

Tower Glass Door	<b>H/TG-1872-3-(L or R)-20</b>	20	18	72	4975	17	165
	<b>H/TG-1872-3-(L or R)-24</b>	24	18	72	5350	17	165

•Specify: (R)ight if hinge is on the right  
(L)eft if hinge is on the left  
•For Glass Shelves Add 75

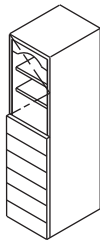
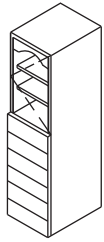

Tower Wood Door	<b>H/TW-1872-3-(L or R)-20</b>	20	18	72	4675	17	175
	<b>H/TW-1872-3-(L or R)-24</b>	24	18	72	5050	17	175

•Specify: (R)ight if hinge is on the right  
(L)eft if hinge is on the left

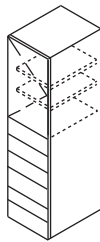
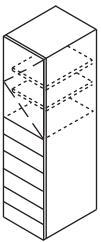

Specify Model Number, Wood Finish, and Optional Accessories

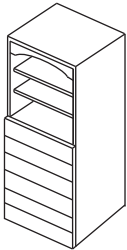
	Model No.	Depth	Width	Height	Price	Cubic Feet	Weight
Tower Open 	<b>H/TO-3072-3-20</b>	20	30	72	5125	27	200
	<b>H/TO-3672-3-20</b>	20	36	72	5750	27	180
	<b>H/TO-3072-3-24</b>	24	30	72	5625	27	200
	<b>H/TO-3672-3-24</b>	24	36	72	6250	27	180
•For Glass Shelves Add 150							

Tower Glass Door 	<b>H/TG-3072-3-20</b>	20	30	72	6550	27	210
	<b>H/TG-3672-3-20</b>	20	36	72	7175	27	180
	<b>H/TG-3072-3-24</b>	24	30	72	7050	27	210
	<b>H/TG-3672-3-24</b>	24	36	72	7675	27	180
•For Glass Shelves Add 150							

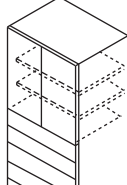
Tower Wood Door 	<b>H/TW-3072-3-20</b>	20	30	72	5925	27	220
	<b>H/TW-3672-3-20</b>	20	36	72	6550	27	180
	<b>H/TW-3072-3-24</b>	24	30	72	6425	27	220
	<b>H/TW-3672-3-24</b>	24	36	72	7050	27	180

Specify Model Number, Wood Finish, and Optional Accessories

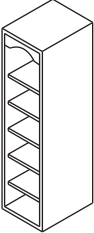
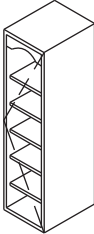
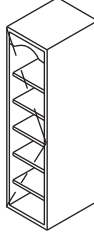
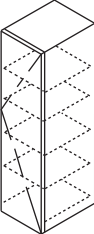
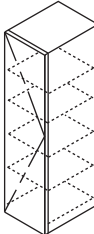
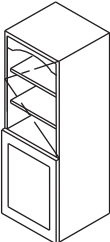
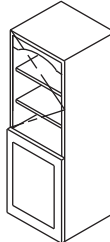
	Model No.	Depth	Width	Height	Price	Cubic Feet	Weight
Tower Open	<b>H/TO-1872-4-20</b>	20	18	72	3425	17	150
	<b>H/TO-1872-4-24</b>	24	18	72	3800	17	150
	•For Glass Shelves Add 175						
Tower Glass Door	<b>H/TG-1872-4-(L or R)-20</b>	20	18	72	4050	17	135
	<b>H/TG-1872-4-(L or R)-24</b>	24	18	72	4425	17	135
	•Specify: (R)ight if hinge is on the right (L)eft if hinge is on the left •For Glass Shelves Add 175						
Tower Wood Door	<b>H/TW-1872-4-(L or R)-20</b>	20	18	72	3725	17	175
	<b>H/TW-1872-4-(L or R)-24</b>	24	18	72	4100	17	175
	•Specify: (R)ight if hinge is on the right (L)eft if hinge is on the left						
Tower Electronic Storage	<b>H/TE-2472-5-(L or R)-20</b>	20	24	72	4200	26	200
	<b>H/TE-2472-5-(L or R)-24</b>	24	24	72	4575	26	200
	•Specify: (R)ight if hinge is on the right (L)eft if hinge is on the left •For Glass Shelves Add 75						

Specify Model Number, Wood Finish, and Optional Accessories

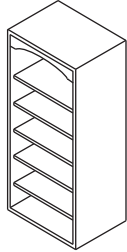
	Model No.	Depth	Width	Height	Price	Cubic Feet	Weight
Tower Open 	<b>H/TO-3072-4-20</b>	20	30	72	3875	27	155
	<b>H/TO-3672-4-20</b>	20	36	72	4500	27	180
	<b>H/TO-3072-4-24</b>	24	30	72	4375	27	155
	<b>H/TO-3672-4-24</b>	24	36	72	5000	27	180
	•For Glass Shelves Add 225						

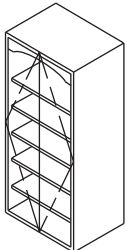
Tower Glass Door 	<b>H/TG-3072-4-20</b>	20	30	72	4825	27	185
	<b>H/TG-3672-4-20</b>	20	36	72	5450	27	180
	<b>H/TG-3072-4-24</b>	24	30	72	5325	27	185
	<b>H/TG-3672-4-24</b>	24	36	72	5950	27	180
	•For Glass Shelves Add 225						

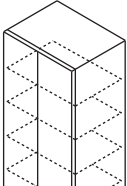
Tower Wood Door 	<b>H/TW-3072-4-20</b>	20	30	72	4500	27	200
	<b>H/TW-3672-4-20</b>	20	36	72	5125	27	180
	<b>H/TW-3072-4-24</b>	24	30	72	5000	27	200
	<b>H/TW-3672-4-24</b>	24	36	72	5625	27	180

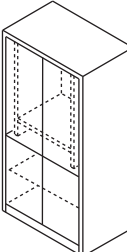
Tower Audio Visual Unit 	<b>H/TAV-3672-6</b>	24	36	72	6700	39	275
--	---------------------	----	----	----	------	----	-----

Specify Model Number, Wood Finish, and Optional Accessories

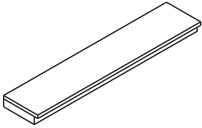
	Model No.	Depth	Width	Height	Price	Cubic Feet	Weight
<p>Tower Straight Shelf</p> 	<b>H/TSS-1442</b>	14	42	4	1175	1.8	20
	<b>H/TSS-1448</b>	14	48	4	1250	2.0	22
	<b>H/TSS-1454</b>	14	54	4	1325	2.1	24
	<b>H/TSS-1460</b>	14	60	4	1425	2.2	26
	<b>H/TSS-1466</b>	14	66	4	1475	2.3	28
	<b>H/TSS-1472</b>	14	72	4	1575	2.5	30
	<b>H/TSS-1478</b>	14	78	4	1625	2.8	32
	<b>H/TSS-1484</b>	14	84	4	1725	3.0	34

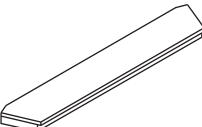

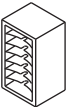
<p>Tower Angled Shelf</p> 	<b>H/TAS-1470</b>	14	70	4	1725	2.5	30
	<b>H/TAS-1476</b>	14	76	4	1800	2.8	32
	<b>H/TAS-1482</b>	14	82	4	1875	3.0	34
	<b>H/TAS-1488</b>	14	88	4	1950	3.3	36
	<b>H/TAS-1494</b>	14	94	4	2050	3.5	38
	<b>H/TAS-14100</b>	14	100	4	2200	3.8	40
	<b>H/TAS-14106</b>	14	106	4	2250	4.0	42
	<b>H/TAS-14112</b>	14	112	4	2350	4.3	44

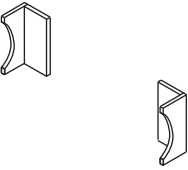
<p>Paper Organizer Shelf Support</p> 	<b>H/POS-1224</b>	9	12	24	950	1.5	20
---	-------------------	---	----	----	-----	-----	----

<p>Shelf/Tack Panel Support (Pair)</p> 	<b>H/SPS-1224</b>	9	12	24	550	1.5	15
---	-------------------	---	----	----	-----	-----	----

<p>Wardrobe Pole Kit</p> 	<b>H/WPK-16</b>		16 <sup>1/2</sup>		50	0.5	2
	<b>H/WPK-28</b>		28 <sup>1/2</sup>		75	1.0	3

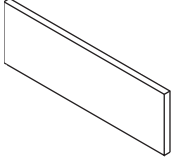
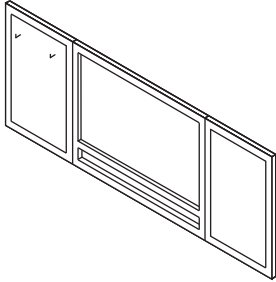
Specify Model Number, Wood Finish, and Optional Accessories

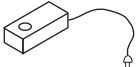
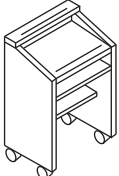
	Model No.	Depth	Width	Height	Price	Cubic Feet	Weight	
<b>Fabric Tack Panel</b> 	<b>H/FTP-2436</b>	1 <sup>1</sup> / <sub>2</sub>	36	24	375	.9	7	
	<b>H/FTP-2442</b>	1 <sup>1</sup> / <sub>2</sub>	42	24	375	1.0	8	
	<b>H/FTP-2448</b>	1 <sup>1</sup> / <sub>2</sub>	48	24	400	1.1	9	
	<b>H/FTP-2454</b>	1 <sup>1</sup> / <sub>2</sub>	54	24	425	1.2	10	
	<b>H/FTP-2460</b>	1 <sup>1</sup> / <sub>2</sub>	60	24	450	1.3	11	
	<b>H/FTP-2466</b>	1 <sup>1</sup> / <sub>2</sub>	66	24	475	1.4	12	
	<b>H/FTP-2472</b>	1 <sup>1</sup> / <sub>2</sub>	72	24	500	1.5	13	
	<b>H/FTP-2478</b>	1 <sup>1</sup> / <sub>2</sub>	78	24	500	1.6	14	
	<b>H/FTP-2484</b>	1 <sup>1</sup> / <sub>2</sub>	84	24	550	1.7	15	
	<b>H/FTP-2490</b>	1 <sup>1</sup> / <sub>2</sub>	90	24	575	1.8	16	
	<b>H/FTP-2496</b>	1 <sup>1</sup> / <sub>2</sub>	96	24	600	1.9	17	
<b>Presentation Board</b> 	Magnetic white board center with tackable fabric inside doors	<b>H/PB-4836</b>	3	48	36	2800	3.0	120
		<b>H/PB-4848</b>	3	48	48	2950	4.0	160
		<b>H/PB-6048</b>	3	60	48	3250	5.0	200
		<b>H/PB-7248</b>	3	72	48	3725	6.0	240
		•Pull-down Projection Screen: Add 400 •Fabric: Maharam						
<b>Halogen Task Light</b> 	<b>H/HTL-13</b>		2 <sup>5</sup> / <sub>8</sub>	7/ <sub>8</sub>	225			
	•Requires Transformer							
<b>Transformer</b> 	<b>H/HTF-36</b>	2	6	2	225	0.5	3	
	•Powers One To Three Halogen Task Lights							
<b>Mobile Lectern</b> 	<b>H/MBL-1824</b>	18	24	48	4350	12.0	75	

Specify Model Number, Wood Finish, and Optional Accessories

Angle Bow Conference Table

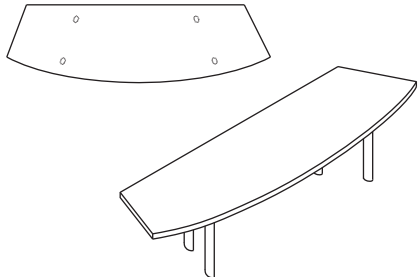

Model No.	Depth	Width	Height	Price	Cubic Feet	Weight
H/ABCT-30108	30	108	29	5450	8.0	130
H/ABCT-30120	30	120	29	6225	8.5	150
H/ABCT-30144	30	144	29	7000	8.5	170
H/ABCT-36108	36	108	29	5750	8.5	155
H/ABCT-36120	36	120	29	6550	9.0	170
H/ABCT-36144	36	144	29	7300	10.0	200
H/ABCT-30168	30	168	29	10100	9.5	190
H/ABCT-30192	30	192	29	11675	10.5	210
H/ABCT-30216	30	216	29	13200	12.0	230
H/ABCT-36168	36	168	29	10425	11.0	230
H/ABCT-36192	36	192	29	11975	12.0	260
H/ABCT-36216	36	216	29	13500	13.5	290

•Tables 168" and larger have two-piece tops and eight legs

Pentagon Conference Table

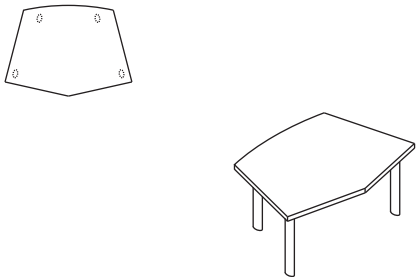

H/PTCT-4057-29	40	57	29	4500	7.0	100
H/PTCT-4057-27	40	57	27	4500	7.0	100

•27" tall tables slide under 29" tall tables

Round Conference Table

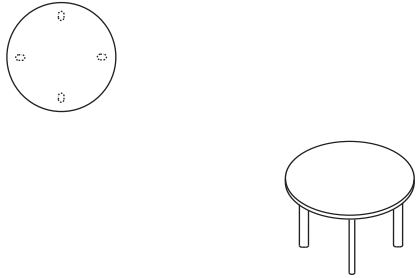

	Diameter		Height	Price	Cubic Feet	Weight
H/RDCT-36-xx	36	29	1975	6.0	70	
H/RDCT-42-xx	42	29	2300	6.5	80	
H/RDCT-48-xx	48	29	2600	7.0	90	
H/RDCT-54-xx	54	29	3225	7.5	100	
H/RDCT-60-xx	60	29	3850	8.0	110	

•For 27" tall tables substitute 27 for **xx**  
 •For 29" tall tables substitute 29 for **xx**

Specify Model Number, Wood Finish, and Optional Accessories

Boat Shape Conference Table

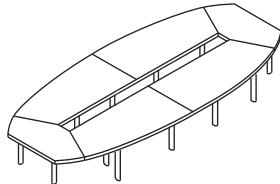
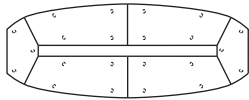
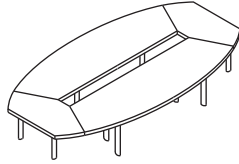
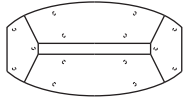

Model No.	Depth	Width	Height	Price	Use This Power-Trough See Page 50	Cubic Feet	Weight
<b>H/BTCT-69144</b>	69	144	29	25725	H/PT-102	20	375
<b>H/BTCT-69168</b>	69	168	29	28300	H/PT-126	22	400
•4 piece top/14 black legs							
<b>H/BTCT-69192</b>	69	192	29	33450	H/PT-150	24	425
<b>H/BTCT-69216</b>	69	216	29	36000	H/PT-174	26	450
<b>H/BTCT-69240</b>	69	240	29	38575	H/PT-198	28	475
<b>H/BTCT-69264</b>	69	264	29	41175	H/PT-222	30	500
<b>H/BTCT-69288</b>	69	288	29	43725	H/PT-246	32	525
•6 piece top/22 black legs							

Oval Conference Table

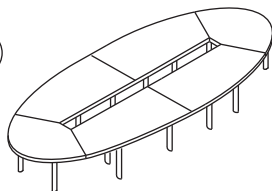
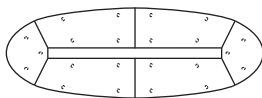
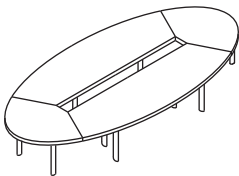
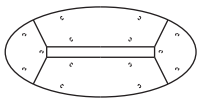

<b>H/OVCT-69144</b>	69	144	29	29575	H/PT-78	20	375
<b>H/OVCT-69168</b>	69	168	29	32175	H/PT-102	22	400
<b>H/OVCT-69192</b>	69	192	29	37300	H/PT-126	24	425
•4 piece top/14 black legs							
<b>H/OVCT-69216</b>	69	216	29	39850	H/PT-150	26	450
<b>H/OVCT-69240</b>	69	240	29	42450	H/PT-174	28	475
<b>H/OVCT-69264</b>	69	264	29	45000	H/PT-198	30	500
<b>H/OVCT-69288</b>	69	288	29	47575	H/PT-222	32	525
•6 piece top/22 black legs							

Specify Model Number, Wood Finish, and Optional Accessories

Voice/Data/Power Options

Model No.

Price

Power Sphere

**VDP-PS**

300

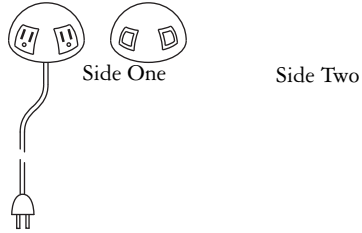

Includes: Two power outlets with 6' cord on side one  
Two RJ-45 data/communications jacks on side two

VDP Pop-up

**VDP-PU**

450

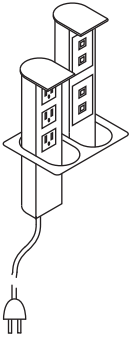

Includes: Three power receptacles with 6' cord  
Four RJ-45 data/communications jacks

VDP Power Trough

**H/PT-78**

3850

No. Of Sections

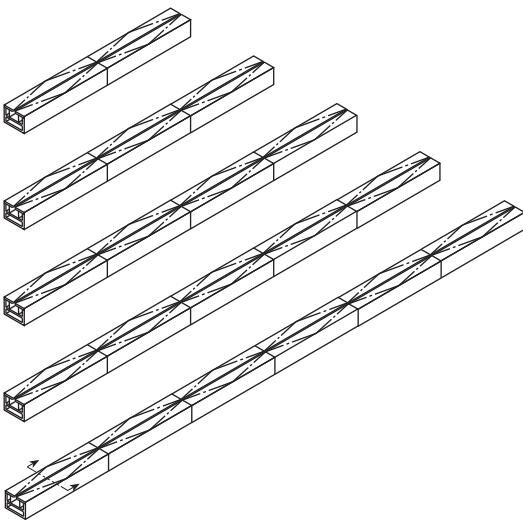

**H/PT-102**

5800

3

**H/PT-126**

6075

3

**H/PT-150**

7700

4

**H/PT-174**

8100

4

**H/PT-198**

9625

5

**H/PT-222**

11550

6

**H/PT-246**

12175

6

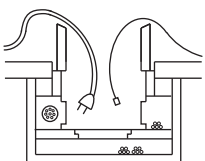

Access Doors Open

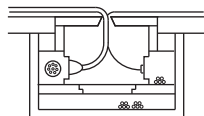

Access Doors Closed

- Fits Helios boat shape and oval conference tables
- Access doors are wood finished to match table top
- Interior is finished matte black
- Each section contains:
  - Four power receptacles
  - Four RJ-45 data/communications jacks
- Power is distributed by means of quick-disconnect power harnesses. The included power feed harness must be hard-wired to the building source.

Specify Model Number, Wood Finish, and Optional Accessories





Architectural Response  
Kollektion, Inc  
2918 Halladay Street  
Santa Ana, California 92705

Tel. 714.241.7100

Fax: 714.241.7600

Toll Free 888.241.7100

Email [info@ark-inc.com](mailto:info@ark-inc.com)

[www.ark-inc.com](http://www.ark-inc.com)

