



Elysian  
collection

ARK

Price Book 2010



Table of Contents

---

Terms and Conditions of Sale	2
General Specifications	5
Desks and Credenza Assemblies	6
Desks, Returns, Bridges and Credenza Components	15
Freestanding Workstations	24
Workstation Components, Audio Visual Units, Presentation Boards	26
Hutches, Wall-Hung Overhead Storage, Task Lighting, Tack Panels	28
Reception Desks and Components	36
Conference Tables	44
Occasional Tables	50
Bookcases	51

---

---

## Terms and Conditions of Sale

---

### Prices

All prices herein are delivered list prices effective the date printed on the cover and supersede all other published price lists.

Prices shown are for standard product only. Standard product will have additional charges applied to it for any changes made. Architectural Response Kollection, Inc. reserves the right to change prices and specifications without prior notice.

Pricing shown does not include installation, taxes, packaging, crating or storage. Orders are acknowledged with net prices. Minimum order charge is \$50 net.

---

### Acknowledgement

Each order will be acknowledged. This acknowledgement is the final agreement between Architectural Response Kollection, Inc. and the customer, superceding all previous communications regarding the order.

---

### Product Design

Architectural Response Kollection, Inc. reserves the right to make changes in design and construction or discontinue products without prior notice.

---

### Terms

Our terms are Net 30 days. Credit references and resale certificate must be submitted prior to receipt of your initial order. Open account status or terms of sale may be established at the discretion of Architectural Response Kollection, Inc.

After 30 days from date of invoice a 1 1/2% interest charge will be added on any unpaid balance. Architectural

Response Kollection, Inc. may retain a security interest in the furniture until full payment of the invoice.

---

### Ordering Procedures

Orders should be submitted through our authorized Factory Representative or may be sent directly to:

Architectural Response Kollection, Inc.  
2918 Halladay Street  
Santa Ana, California 92705

Tel. 714 241.7100  
Toll-free 888 241.7100  
Fax. 714 241.7600

---

### Cancellations and Changes

Request for cancellation and changes will be accepted if they are of a reasonable nature as determined by Architectural Response Kollection, Inc., and they are received in written form prior to the start of production. To cancel an order a fee of 25% or more may be imposed at our discretion. Change orders for products in production are based on our ability to conform and will also be subject to an appropriate fee to be based on our expenses. Special product orders may not be cancelled.

---

### Packing

All prices are for blanket wrap. For special packing requirements, contact the sales office. All weights stated herein are approximate. All products are shipped according to freight regulations. The ordering party bears the risk of loss or damage during shipment.

---

### Delivery and Freight Charges

All shipments are F.A.S. point of shipment, freight prepaid and allowed to one continental U.S. destination. All shipments outside the continental United States will be shipped FAS origin, freight prepaid to point of embarkation. All charges beyond point of embarkation are collect. Orders in production will be shipped as scheduled and cannot be held.

Architectural Response Kollection, Inc. reserves the right to select the most appropriate carrier and routing for all shipments.

Inside delivery and installation services are not included in the pricing shown.

Orders will be invoiced within 48 hours after notifying the customer of completion. If customer is unable to accept delivery of merchandise when ready for shipment, Architectural Response Kollection, Inc. may transfer the merchandise to storage. All costs including transportation will be at customers expense.

A storage charge of 1 1/2% of invoice will be assessed for every 30 days, or any part thereof, that merchandise remains in storage. Architectural Response Kollection, Inc. considers transfer to storage the equivalent of delivery for all purposes, including invoicing and payment. Customers will bear all risk of damage or loss during storage.

Architectural Response Kollection, Inc. is not liable for any delay for failure to deliver products due to: fires, floods, accidents, labor strikes, lock outs, earthquakes, delay or failure of material supply sources, acts of God, or any other causes beyond Architectural Response Kollection, Inc.'s control.

---

Claims

Architectural Response Kollection, Inc. takes every precaution to assure proper inspection of the loading and packing of all merchandise. Our liability ceases when we receive a clear bill of lading at our shipping dock. This is an acknowledgement by the transportation company that the merchandise was received in good condition.

---

Damaged Merchandise

Do not refuse merchandise damaged in transit. All shipments are delivered to the transportation company in good condition. Architectural Response Kollection, Inc.'s liability ceases at that time. If a shipment is received damaged you should immediately file a claim with the transportation company.

---

Concealed Damage and Shortages

Customers are protected from concealed damage and shortages if they file claims with the carrier within five days of delivery. ARK suggests that the words "subject to inspection" accompany signature if goods are crated or cartoned and thus cannot be examined at time of receipt. Any claims for shipping damage must be filed by the customer with the carrier within five days of receipt.

---

Repair Charges

Factory authorization must be secured from Architectural Response Kollection, Inc. prior to incurring repair charges if Architectural Response Kollection, Inc. is expected to pay these charges.

Merchandise may not be returned without our prior written authorization along with shipping instructions. Unauthorized returns will not be accepted and will be returned freight collect.

All merchandise being returned must be properly packed and protected to ensure no further damage is incurred during transportation back to Architectural Response Kollection, Inc.'s facility. Upon receipt, all returned merchandise will be thoroughly inspected and the results compared to the reason for return stated on the RGA. Any discrepancies, such as additional damage, signs of usage, missing parts, etc., will result in an adjustment to the amount of credit issued.

---

Warranty

All Architectural Response Kollection, Inc. products are manufactured according to our high standards for fine quality materials and workmanship. We warrant all standard catalog items against failure due to defective materials or workmanship for a period of ten years of single shift service from the date of shipment.

This warranty does not apply to damages, neglect, misused or altered products, nor defects in materials not manufactured by Architectural Response Kollection, Inc. Excluded from this warranty are leathers, marble and granite surfaces.

The manufacturer cannot guarantee any product, stored or set in place, in an environment where temperature and humidity are not controlled.

---

Care and Maintenance

When cleaning, use a soft cotton cloth moistened with a mild soap and warm water solution and dry immediately. ARK does not recommend the use of waxes or polishes.

---

Color and Grain Matching

Different wood species offer unique texture and grain. Variations in finish color and value may occur due to the natural characteristics of wood. Architectural Response Kollection, Inc. carefully selects all materials used in every product to minimize the natural variation in materials. Exact color match is not possible.

When re-ordering furniture for an existing project, where color change has occurred as a natural part of the aging process, please provide sample if color matching is critical.



Ordering Information

Standard Features

Locks are standard on all drawer pedestals. Lock finish is matte black.

Pulls

- Pulls on all drawer and lower storage pedestals are available in brushed nickel and black.
- All workstation module upper and full length doors are touch-latch.
- Overhead storage doors have a bottom fingerpull.

Box drawers have one fully adjustable drawer divider.

File drawers accommodate side-to-side legal and letter hanging files.

Pencil tray – each desk without a center drawer is furnished with one pencil tray located in a top box drawer.

All VDT tables and CRT corners are furnished with a 2 1/2" grommet.

4" diameter step-column legs on conference desks and P-top desks are available in the following finishes:

<i>Metal</i>	<i>Finish</i>
BL	Black Matte
BN	Brushed Nickel
PC	Polished Chrome

5" square legs on table desks are wood finished to match tops. The apron substructure has a matte black finish.

Materials

<i>Wood</i>	<i>Finish</i>
Cherry	LC 501 Light Cherry
	MC 502 Medium Cherry
	DC 503 Dark Cherry
Maple	NM 400 Natural Maple
	HM 404 Honey Maple

Standard finishes are in a 45 sheen.

Prices listed are with open pore finishes. Semi-filled tops are available at a 10% upcharge. Fully-filled tops are available at a 20% upcharge.

Most requests for special finishes can be accommodated at a 15% upcharge.

Standard Fabric for tackable surfaces is Maharam (fabric to be determined)

Approved Fabric Substitutes:

- Maharam
- Tek-Wall 1000
  - Tek-Wall Merit
  - Tek-Wall Herald

Guilford of Maine

- FR701
- Belgrade
- Shagreen

Standard Leather – Black

Standard Stone – Absolute Black Granite

The option of additional stones and leathers is available. Please contact the factory for pricing.

Elysian Edge and Leg Details

1 1/4" subtop with a 3/4" floating top separated by a 1/4" black reveal

Solid hardwood band front and back on desks, and front edge only on returns, credenzas and bookcases.

Racetrack oval and rectangular conference tables – 1 3/4" subtop with a 3/4" floating top separated by a 1/4" black reveal.

Round conference tables – 1 1/4" subtop with a 3/4" floating top separated by a

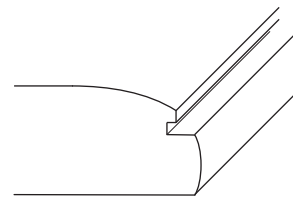

E01 Edge

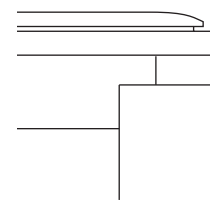

Leg Detail

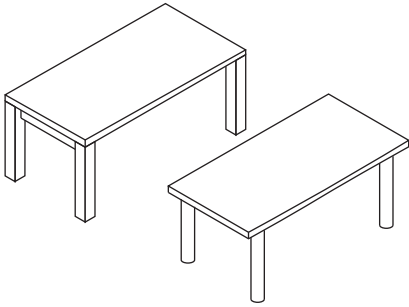
	Model No.	Depth	Width	Height	Price	Add for Stone	Add for Leather	Cubic Feet	Weight
<b>Table Desk</b> 	<b>E/TD/R-3672</b>	36	72	29	6200	5850	1950	43.5	175
	<b>E/TD/R-3678</b>	36	78	29	6350	6350	2100	47.1	205
	<b>E/TD/R-4284</b>	42	84	29	6950	7950	2700	59.2	220

- Specify Square or Round Legs
- For center drawer: Add 500

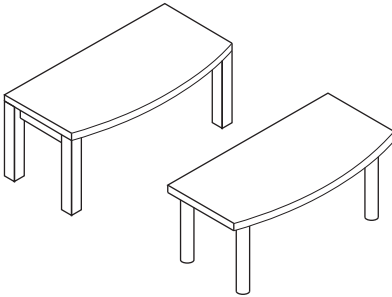
<b>Bow Front Table Desk</b> 	<b>E/TD/B-3672</b>	36	72	29	6500	6500	1950	43.5	125
	<b>E/TD/B-3678</b>	36	78	29	6800	7050	2100	47.1	155
	<b>E/TD/B-4284</b>	42	84	29	7225	8850	2700	59.2	170

- Specify Square or Round Legs
- For center drawer: Add 500

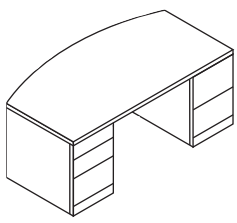
<b>Bow Front Double Pedestal</b> 	<b>E/DP/B-3060</b>	30	60	29	6075	4500	1375	30.2	285
	<b>E/DP/B-3066</b>	30	66	29	6350	4975	1550	33.2	295
	<b>E/DP/B-3072</b>	30	72	29	6500	5975	1875	37.5	170
	<b>E/DP/B-3672</b>	36	72	29	6675	6500	1950	43.5	310
	<b>E/DP/B-3678</b>	36	78	29	6950	7050	2125	47.1	340
	<b>E/DP/B-4284</b>	42	84	29	7500	8850	2700	59.2	355

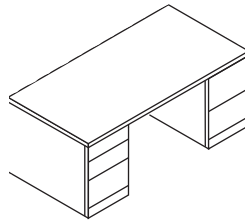
<b>Double Pedestal</b> 	<b>E/DP/R-3060</b>	30	60	29	5800	4100	1375	30.2	285
	<b>E/DP/R-3066</b>	30	66	29	6075	4475	1550	33.2	295
	<b>E/DP/R-3072</b>	30	72	29	6225	5350	1875	37.5	300
	<b>E/DP/R-3672</b>	36	72	29	6350	5850	1950	43.5	310
	<b>E/DP/R-3678</b>	36	78	29	6675	6350	2125	47.1	340
	<b>E/DP/R-4284</b>	42	84	29	7225	7950	2700	59.2	355

Specify Model Number, Wood Finish, Edge Detail and Optional Accessories

Lateral File Credenza

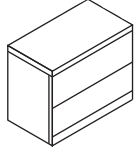

Model No.	Depth	Width	Height	Price	Add for Stone	Add for Leather	Cubic Feet	Weight
<b>E/CR-2030-1</b>	20	30	29	2825	1600	550	10.5	120
<b>E/CR-2036-1</b>	20	36	29	3050	1925	675	12.7	130
<b>E/CR-2430-1</b>	24	30	29	3125	1625	550	12.5	128
<b>E/CR-2436-1</b>	24	36	29	3325	1950	675	14.5	140

Three-High Lateral File Credenza

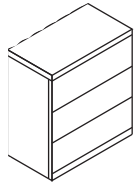

<b>E/CR-2030-13</b>	20	30	41 <sup>1/2</sup>	4225	1600	550	15.8	180
<b>E/CR-2036-13</b>	20	36	41 <sup>1/2</sup>	4575	1925	675	19.0	195
<b>E/CR-2430-13</b>	24	30	41 <sup>1/2</sup>	4700	1625	550	18.9	192
<b>E/CR-2436-13</b>	24	36	41 <sup>1/2</sup>	4975	1950	675	21.8	210

Four-High Lateral File Credenza

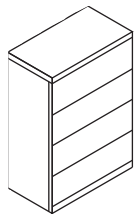

<b>E/CR-2030-14</b>	20	30	54	5625	1600	550	21.0	240
<b>E/CR-2036-14</b>	20	36	54	6075	1925	675	25.4	260
<b>E/CR-2430-14</b>	24	30	54	6250	1625	550	25.0	256
<b>E/CR-2436-14</b>	24	36	54	6625	1950	675	29.0	280

Lateral File Credenza

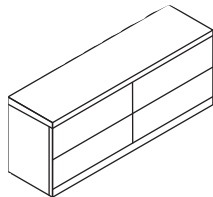

<b>E/CR-2060-1</b>	20	60	29	5500	3225	1100	20.8	240
<b>E/CR-2072-1</b>	20	72	29	6200	3875	1325	25.4	260
<b>E/CR-2460-1</b>	24	60	29	5950	3250	1100	25.0	256
<b>E/CR-2472-1</b>	24	72	29	6675	3575	1325	29.0	280

Specify Model Number, Wood Finish, Edge Detail and Optional Accessories

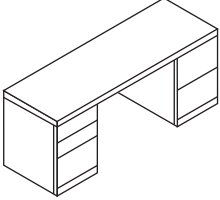
	Model No.	Depth	Width	Height	Price	Add for Stone	Add for Leather	Cubic Feet	Weight
<p>Kneespace Credenza</p> 	<b>E/CR-2066-4</b>	20	66	29	5075	3225	1100	23.3	200
	<b>E/CR-2072-4</b>	20	72	29	5350	3550	1200	25.4	205
	<b>E/CR-2078-4</b>	20	78	29	5625	3875	1325	27.5	210
	<b>E/CR-2084-4</b>	20	84	29	5950	4200	1425	29.6	215
	<b>E/CR-2466-4</b>	24	66	29	6225	4500	1550	26.5	220
	<b>E/CR-2472-4</b>	24	72	29	5500	3250	1100	29.0	225
	<b>E/CR-2478-4</b>	24	78	29	5825	3575	1200	31.5	230
	<b>E/CR-2484-4</b>	24	84	29	6100	3925	1325	34.0	235

• Includes removable modesty panel @ kneespace  
 • If back is to be exposed, specify fixed modesty panel

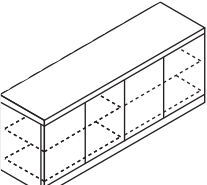
<p>Storage Credenza</p> 	<b>E/CR-2060-2</b>	20	60	29	4875	4225	1425	20.8	220
	<b>E/CR-2072-2</b>	20	72	29	5575	4575	1550	25.4	230
	<b>E/CR-2460-2</b>	24	60	29	5200	3225	1100	25.0	226
	<b>E/CR-2472-2</b>	24	72	29	5925	3875	1325	29.0	250

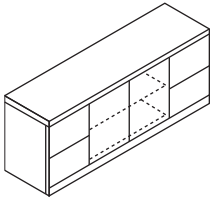
<p>File/Storage Credenza</p> 	<b>E/CR-2072-3</b>	20	72	29	6750	3250	1100	25.4	245
	<b>E/CR-2472-3</b>	24	72	29	7325	3575	1325	29.0	265

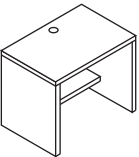
<p>VDT Table</p> 	<b>E/VT-2030-1</b>	20	30	29	2875			10.5	105
	<b>E/VT-2036-1</b>	20	36	29	3200			12.7	110
	<b>E/VT-2436-1</b>	24	36	29	3475			12.5	120
	<b>E/VT-2442-1</b>	24	42	29	3750			17.5	125

VDT tables include 2 1/2" grommet and shelf

- For articulating keyboard arm: Add 375
- For keyboard drawer: Add 225
- For casters: Add 125

Specify Model Number, Wood Finish, Edge Detail and Optional Accessories

Rectangular L-Desk  
 Right return shown, specify (R)ight or (L)eft

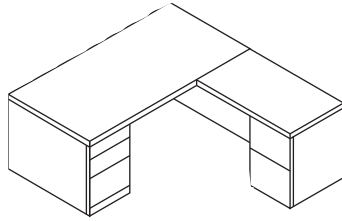

Model No.	Depth	Width	Height	Price	Cubic Feet	Weight
<b>E/LD/R-6672(R or L)</b>				8425	47.0	360
Desk	30	66	29			
Return	24	42	29			
<b>E/LD/R-7272(R or L)</b>				8550	50.3	380
Desk	30	72	29			
Return	24	42	29			
<b>E/LD/R-7278(R or L)</b>				8700	60.4	450
Desk	36	72	29			
Return	24	42	29			
<b>E/LD/R-7878(R or L)</b>				8975	64.0	470
Desk	36	78	29			
Return	24	42	29			
<b>E/LD/R-8484(R or L)</b>				9425	76.1	495
Desk	42	84	29			
Return	24	42	29			

Bow Front L-Desk  
 Right return shown, specify (R)ight or (L)eft

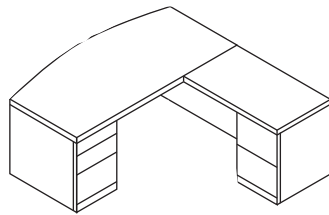

<b>E/LD/B-7272(R or L)</b>				8975		
Desk	30	72	29		50.3	380
Return	24	42	29			
<b>E/LD/B-7278(R or L)</b>				9125	60.4	450
Desk	36	72	29			
Return	24	42	29			
<b>E/LD/B-7878(R or L)</b>				9700	64.0	470
Desk	36	78	29			
Return	24	42	29			
<b>E/LD/B-8484(R or L)</b>				10000	76.1	495
Desk	42	84	29			
Return	24	42	29			

Specify Model Number, Wood Finish, Edge Detail and Optional Accessories

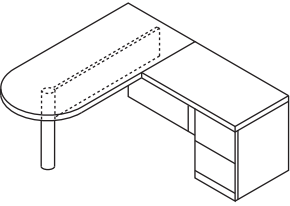
	Model No.	Depth	Width	Height	Price	Cubic Feet	Weight
<p>Conference L-Desk Right return shown, specify (R)ight or (L)eft</p> 	<b>E/LD/C-6672(R or L)</b>				8425	48.0	260
	Desk	30	66	29			
	Return	24	42	29			
	<b>E/LD/C-7272(R or L)</b>				8550	50.3	280
	Desk	30	72	29			
	Return	24	42	29			
	<b>E/LD/C-7278(R or L)</b>				8700	60.4	300
	Desk	36	72	29			
	Return	24	42	29			
	<b>E/LD/C-7878(R or L)</b>				8975	64.0	310
Desk	36	78	29				
Return	24	42	29				
<b>E/LD/C-8484(R or L)</b>				9425	76.1	325	
Desk	42	84	29				
Return	24	42	29				

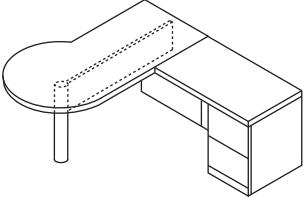
<p>P-Top L-Desk Right return shown, specify (R)ight or (L)eft</p> 	<b>E/LD/P-7284(R or L)</b>				10575	61.0	305
	Desk	30/42	72	29			
	Return	24	42	29			
	<b>E/LD/P-7884(R or L)</b>				10850	65.5	320
	Desk	30/42	78	29			
	Return	24	42	29			
	<b>E/LD/P-8484(R or L)</b>				11175	77.6	335
	Desk	30/42	84	29			
	Return	24	42	29			
	<b>E/LD/P-8490(R or L)</b>				11450	81.0	350
Desk	36/48	84	29				
Return	24	42	29				

Specify Model Number, Wood Finish, Edge Detail and Optional Accessories

Rectangular U-Desk  
Right return shown, specify (R)ight or (L)eft

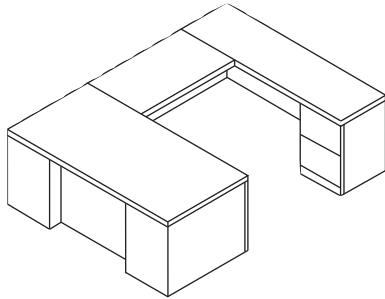

Model No.	Depth	Width	Height	Price	Cubic Feet	Weight
<b>E/UD/R-7296(R or L)</b>				12000	88.3	570
Desk	30	72	29			
Return	24	42	29			
Credenza	24	72	29			
<b>E/UD/R-72102(R or L)</b>				12175	89.4	590
Desk	36	72	29			
Return	24	42	29			
Credenza	24	72	29			
<b>E/UD/R-78102(R or L)</b>				12725	91.8	620
Desk	36	78	29			
Return	24	42	29			
Credenza	24	78	29			
<b>E/UD/R-84108(R or L)</b>				13450	94.2	655
Desk	42	84	29			
Return	24	42	29			
Credenza	24	84	29			

Bow Front U-Desk  
Right return shown, specify (R)ight or (L)eft

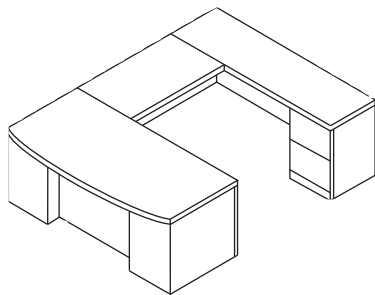

<b>E/UD/B-7296(R or L)</b>				12450	88.3	570
Desk	30	72	29			
Return	24	42	29			
Credenza	24	72	29			
<b>E/UD/B-72102(R or L)</b>				12600	89.4	590
Desk	36	72	29			
Return	24	42	29			
Credenza	24	72	29			
<b>E/UD/B-78102(R or L)</b>				13450	91.8	620
Desk	36	78	29			
Return	24	42	29			
Credenza	24	78	29			
<b>E/UD/B-84108(R or L)</b>				14050	94.2	655
Desk	42	84	29			
Return	24	42	29			
Credenza	24	84	29			

Specify Model Number, Wood Finish, Edge Detail and Optional Accessories

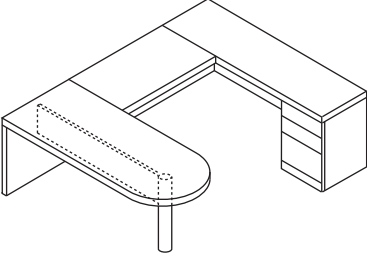
Model No.	Depth	Width	Height	Price	Cubic Feet	Weight
<b>Conference U-Desk</b>						
Right return shown, specify (R)ight or (L)eft						
						
<b>E/UD/C-7296(R or L)</b>				12000	88.3	410
Desk	30	72	29			
Return	24	42	29			
Credenza	24	72	29			
<b>E/UD/C-72102(R or L)</b>				12175	89.4	440
Desk	36	72	29			
Return	24	42	29			
Credenza	24	72	29			
<b>E/UD/C-78102(R or L)</b>				12725	91.8	46
Desk	36	78	29			
Return	24	42	29			
Credenza	24	78	29			
<b>E/UD/C-84108(R or L)</b>				13450	94.2	485
Desk	42	84	29			
Return	24	42	29			
Credenza	24	84	29			

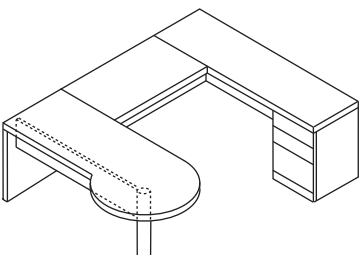
<b>P-Top U-Desk</b>						
Right return shown, specify (R)ight or (L)eft						
						
<b>E/UD/P-72108(R or L)</b>				14050	90.9	455
Desk	30/42	72	29			
Return	24	42	29			
Credenza	24	72	29			
<b>E/UD/P-78108(R or L)</b>				14600	93.3	475
Desk	30/42	78	29			
Return	24	42	29			
Credenza	24	78	29			
<b>E/UD/P-84108(R or L)</b>				15200	94.5	485
Desk	30/42	84	29			
Return	24	42	29			
Credenza	24	84	29			
<b>E/UD/P-84114(R or L)</b>				15475	95.8	500
Desk	36/48	84	29			
Return	24	42	29			
Credenza	24	84	29			

Specify Model Number, Wood Finish, Edge Detail and Optional Accessories

Rectangular U-Desk  
W/CRT Corner  
Right return shown, specify (R)ight or (L)eft

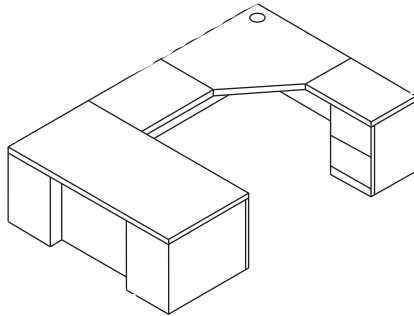

Model No.	Depth	Width	Height	Price	Cubic Feet	Weight
<b>E/CU/R-72102(R or L)</b>				13000	89.1	620
Desk	30	72	29			
Return	24	30	29			
CRT	42	42	29			
Credenza	24	30	29			
<b>E/CU/R-72108(R or L)</b>				13175	99.4	640
Desk	36	72	29			
Return	24	30	29			
CRT	42	42	29			
Credenza	24	36	29			
<b>E/CU/R-78108(R or L)</b>				13450	101.8	670
Desk	36	78	29			
Return	24	30	29			
CRT	42	42	29			
Credenza	24	36	29			
<b>E/CU/R-84114(R or L)</b>				13875	104.2	705
Desk	42	84	29			
Return	24	30	29			
CRT	42	42	29			
Credenza	24	42	29			

Bow Front U-Desk  
W/CRT Corner  
Right return shown, specify (R)ight or (L)eft

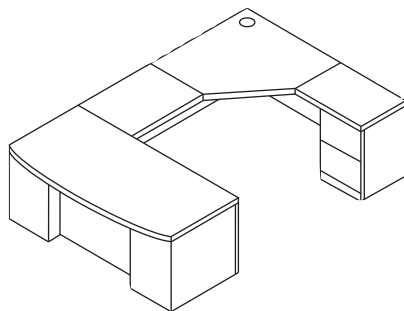

<b>E/CU/B-72102(R or L)</b>				13450	89.1	620
Desk	30	72	29			
Return	24	30	29			
CRT	42	42	29			
Credenza	24	30	29			
<b>E/CU/B-72108(R or L)</b>				13600	99.4	640
Desk	36	72	29			
Return	24	30	29			
CRT	42	42	29			
Credenza	24	36	29			
<b>E/CU/B-78108(R or L)</b>				14175	101.8	670
Desk	36	78	29			
Return	24	30	29			
CRT	42	42	29			
Credenza	24	36	29			
<b>E/CU/B-84114(R or L)</b>				14475	104.2	705
Desk	42	84	29			
Return	24	30	29			
CRT	42	42	29			
Credenza	24	42	29			

Specify Model Number, Wood Finish, Edge Detail and Optional Accessories

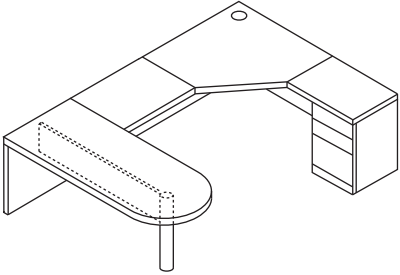
Model No.	Depth	Width	Height	Price	Cubic Feet	Weight
<b>Conference U-Desk</b>						
<b>W/CRT Corner</b>						
Right return shown, specify (R)ight or (L)eft						
	<b>E/CU/C-72102(R or L)</b>			13000	88.1	470
	Desk	30	72	29		
	Return	24	30	29		
	CRT	42	42	29		
	Credenza	24	30	29		
	<b>E/CU/C-72108(R or L)</b>			13175	99.4	490
	Desk	36	72	29		
	Return	24	30	29		
	CRT	42	42	29		
	Credenza	24	36	29		
	<b>E/CU/C-78108(R or L)</b>			13450	101.8	510
	Desk	36	78	29		
	Return	24	30	29		
	CRT	42	42	29		
	Credenza	24	36	29		
	<b>E/CU/C-84114(R or L)</b>			13875	104.2	535
	Desk	42	84	29		
	Return	24	30	29		
	CRT	42	42	29		
	Credenza	24	42	29		

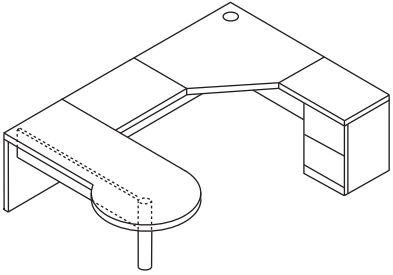
<b>P-Top U-Desk</b>						
<b>W/CRT Corner</b>						
Right return shown, specify (R)ight or (L)eft						
	<b>E/CU/P-72114(R or L)</b>			15050	104.4	500
	Desk	30/42	72	29		
	Return	24	30	29		
	CRT	42	42	29		
	Credenza	24	30	29		
	<b>E/CU/P-78114(R or L)</b>			15325	106.8	520
	Desk	30/42	78	29		
	Return	24	30	29		
	CRT	42	42	29		
	Credenza	24	36	29		
	<b>E/CU/P-84120(R or L)</b>			15925		
	Desk	36/48	84	29		
	Return	24	30	29		
	CRT	42	42	29		
	Credenza	24	42	29		

Specify Model Number, Wood Finish, Edge Detail and Optional Accessories

Desks, Returns, Bridges and Credenzas

The following pages contain the components necessary to specify custom configurations of L-Desks, U-Desks and Credenzas. Find the desired size of desk, return and/or credenza shells and add the pedestals as required.

Pricing Examples

Credenza

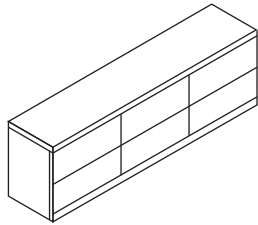

Description:	Price
Credenza consisting of the following:	
E/RC-2490 Credenza Shell	4000
(3) L-M Lateral File Pedestals	<u>4275</u>
Total Price	8275

L-Desk

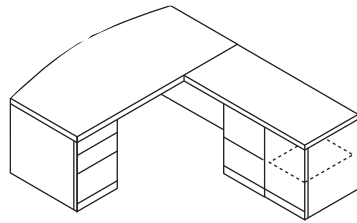

Description:	Price
L-Desk consisting of the following:	
E/SP/B-3678(L-3) Bow Front Desk	5850
E/RC-2454 Return Shell	2400
L-H Swing Door Storage Pedestal	725
L-A File/File Pedestal	<u>1225</u>
Total Price	10200

U-Desk

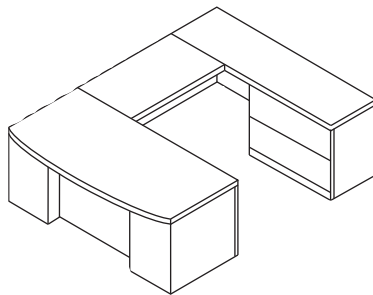

Description:	Price
U-Desk consisting of the following:	
E/SP/B-3678(L-3) Bow Front Desk	5850
E/RC-2454 Return Shell	2400
E/RC-2484 Credenza Shell	3725
L-E End Panel	250
L-K Lateral File Pedestal	<u>1475</u>
Total Price	13700

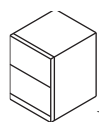

L-2

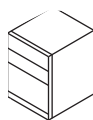

L-3

Desk Pedestals L-2 and L-3 can be interchanged without affecting price.

Rectangular  
Single Pedestal Desk

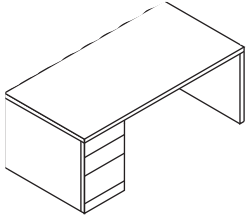

Model No.	Depth	Width	Height	Price	Add for Stone	Add for Leather	Cubic Feet	Weight
<b>E/SP/R-3060(L-3)</b>	30	60	29	4800	4100	1375	31.2	235
<b>E/SP/R-3066(L-3)</b>	30	66	29	5075	4475	1550	34.4	250
<b>E/SP/R-3072(L-3)</b>	30	72	29	5200	5175	1700	37.7	265
<b>E/SP/R-3672(L-3)</b>	36	72	29	5350	5850	1950	45.0	280
<b>E/SP/R-3678(L-3)</b>	36	78	29	5625	6350	2125	48.8	290
<b>E/SP/R-4284(L-3)</b>	42	84	29	6075	7950	2700	61.2	310

Bow Front  
Single Pedestal Desk

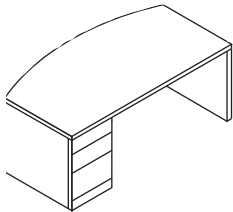

<b>E/SP/B-3060(L-3)</b>	30	60	29	5200	4100	1375	31.2	235
<b>E/SP/B-3066(L-3)</b>	30	66	29	5500	4475	1550	34.4	250
<b>E/SP/B-3072(L-3)</b>	30	72	29	5625	5175	1700	37.7	265
<b>E/SP/B-3672(L-3)</b>	36	72	29	5800	5850	1950	45.0	280
<b>E/SP/B-3678(L-3)</b>	36	78	29	6350	6350	2125	48.8	290
<b>E/SP/B-4284(L-3)</b>	42	84	29	6675	7950	2700	61.2	310

Specify Model Number, Wood Finish, Edge Detail and Optional Accessories

Conference Desk

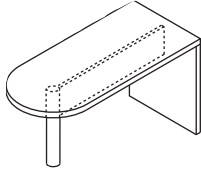

Model No.	Depth	Width	Height	Price	Add for Stone	Add for Leather	Cubic Feet	Weight
<b>E/SP/C-3060</b>	30	60	29	4925	4100	1375	31.2	110
<b>E/SP/C-3066</b>	30	66	29	5075	4475	1550	34.4	120
<b>E/SP/C-3072</b>	30	72	29	5200	5175	1700	37.7	130
<b>E/SP/C-3672</b>	36	72	29	5350	5850	1950	45.0	140
<b>E/SP/C-3678</b>	36	78	29	5625	6350	2125	48.8	150
<b>E/SP/C-4284</b>	42	84	29	6075	7950	2700	61.2	170

P-Top Desk

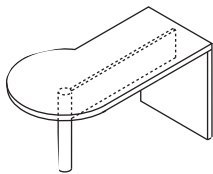

<b>E/SP/P-4272</b>	30/42	72	29	7225	6825	2300	47.0	145
<b>E/SP/P-4278</b>	30/42	78	29	7500	7425	2475	50.8	155
<b>E/SP/P-4284</b>	30/42	84	29	7825	7975	2800	55.4	165
<b>E/SP/P-4884</b>	36/48	84	29	8100	9100	3050	63.2	175

Specify Model Number, Wood Finish, Edge Detail and Optional Accessories

20" Return and Credenza Shells

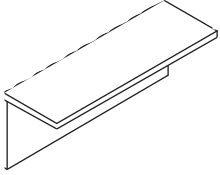

Model No.	Depth	Width	Height	Price	Add for Stone	Add for Leather	Cubic Feet	Weight
<b>E/RC-2018</b>	20	18	29	1325	1000	425	8.5	39
<b>E/RC-2024</b>	20	24	29	1375	1325	475	9.5	49
<b>E/RC-2030</b>	20	30	29	1450	1600	550	10.5	61
<b>E/RC-2036</b>	20	36	29	1600	1925	625	12.5	77
<b>E/RC-2042</b>	20	42	29	1875	2250	750	14.6	85
<b>E/RC-2048</b>	20	48	29	2175	2575	875	16.6	97
<b>E/RC-2054</b>	20	54	29	2475	2875	975	18.7	110
<b>E/RC-2060</b>	20	60	29	2750	3225	1100	20.8	122
<b>E/RC-2066</b>	20	66	29	3050	3550	1200	22.9	134
<b>E/RC-2072</b>	20	72	29	3325	3875	1325	25.0	146
<b>E/RC-2078</b>	20	78	29	3625	4200	1425	27.0	158
<b>E/RC-2084</b>	20	84	29	3925	4500	1550	29.2	170
<b>E/RC-2090</b>	20	90	29	4200	4850	1625	31.2	182
<b>E/RC-2096</b>	20	96	29	4625	5175	1725	33.2	194
<b>E/RC-20108</b>	20	108	29	5350	5825	1950	37.4	220
<b>E/RC-20120</b>	20	120	29	6225	6475	2175	41.6	244
<b>E/RC-20132</b>	20	132	29	7075	7125	2375	45.8	268
<b>E/RC-20144</b>	20	144	29	7950	7750	2600	50.0	292

CRT Corner Unit

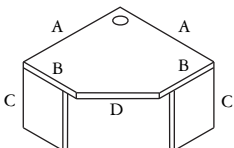

	A	B	C	D			
<b>E/CRT-3620</b>	36	20	22	29	2875		22.5 110
<b>E/CRT-4220</b>	42	20	31	29	3200		30.6 130

Includes 2 1/2" grommet

Specify Model Number, Wood Finish, Edge Detail and Optional Accessories

20" Return, Bridge and Credenza Shell Components

	Model No.	Depth	Width	Height	Price	Cubic Feet	Weight
Two File Drawers	<b>L-A</b>	20	18	27 3/4	1175	5.6	48
Two Box and File Drawers	<b>L-B</b>	20	18	27 3/4	1175	5.6	55

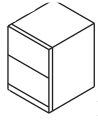

L-A

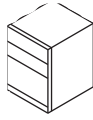

L-B

CPU Pedestal

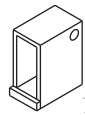

L-D

<b>L-D</b>	20	12	27 3/4	550	4.5	44
------------	----	----	--------	-----	-----	----

- For pull-out shelf Add 150
- For pocket door Add 200

End Panel



L-E

<b>L-E</b>	20	1 1/4	27 3/4	250	0.6	27
------------	----	-------	--------	-----	-----	----

Two Lateral File Drawers

36" <b>L-K</b>	20	36	27 3/4	1450	11.2	73
----------------	----	----	--------	------	------	----

Two Lateral File Drawers

30" <b>L-M</b>	20	30	27 3/4	1375	9.3	61
----------------	----	----	--------	------	-----	----

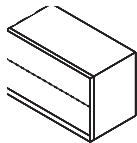

L-K

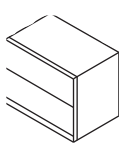

L-M

Swing Door Storage

18" <b>L-H</b>	20	18	27 3/4	700	5.6	44
----------------	----	----	--------	-----	-----	----

Double Swing Door Storage

30" <b>L-P</b>	20	30	27 3/4	1075	9.3	55
----------------	----	----	--------	------	-----	----

Double Swing Door Storage

36" <b>L-J</b>	20	36	27 3/4	1125	11.2	59
----------------	----	----	--------	------	------	----

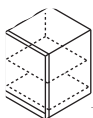

L-H

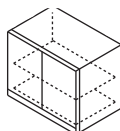

L-P

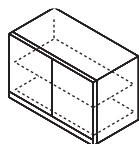

L-J

To be used within a Return or Credenza shell only.

Specify Model Number, Wood Finish, and Optional Accessories

24" Return and Credenza Shells

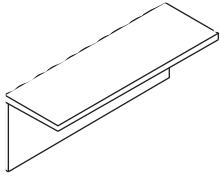

Model No.	Depth	Width	Height	Price	Add for Stone	Add for Leather	Cubic Feet	Weight
<b>E/RC-2418</b>	24	18	29	1375	1000	425	7.5	45
<b>E/RC-2424</b>	24	24	29	1475	1325	475	10.0	60
<b>E/RC-2430</b>	24	30	29	1600	1625	550	12.5	75
<b>E/RC-2436</b>	24	36	29	1725	1950	675	15.0	90
<b>E/RC-2442</b>	24	42	29	2050	2300	750	17.5	105
<b>E/RC-2448</b>	24	48	29	2325	2600	875	20.0	120
<b>E/RC-2454</b>	24	54	29	2600	2950	975	22.5	135
<b>E/RC-2460</b>	24	60	29	2875	3250	1100	25.0	150
<b>E/RC-2466</b>	24	66	29	3200	3575	1200	27.5	165
<b>E/RC-2472</b>	24	72	29	3475	3925	1325	30.0	180
<b>E/RC-2478</b>	24	78	29	3750	4225	1425	32.5	195
<b>E/RC-2484</b>	24	84	29	4050	4575	1550	35.0	210
<b>E/RC-2490</b>	24	90	29	4350	4875	1625	37.5	225
<b>E/RC-2496</b>	24	96	29	4925	5200	1725	40.0	240
<b>E/RC-24108</b>	24	108	29	5800	5850	1950	45.0	270
<b>E/RC-24120</b>	24	120	29	6675	6500	2175	50.0	300
<b>E/RC-24132</b>	24	132	29	7500	7175	2375	55.0	330
<b>E/RC-24144</b>	24	144	29	8375	7825	2600	60.0	360

CRT Corner Unit

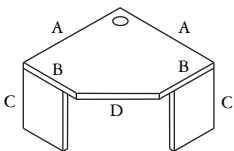

	A	B	C	D		
<b>E/CRT-4224</b>	42	24	25	29	3200	30.6 130
<b>E/CRT-4824</b>	48	24	34	29	3475	40.0 150

Includes 2 1/2" grommet

Specify Model Number, Wood Finish, Edge Detail and Optional Accessories

24" Return, Bridge and Credenza Shell Components

	Model No.	Depth	Width	Height	Price	Cubic Feet	Weight
Two File Drawers	<b>L-A</b>	24	18	27 3/4	1325	6.8	48
Two Box and File Drawers	<b>L-B</b>	24	18	27 3/4	1325	6.8	55

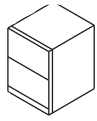

L-A



L-B

CPU Pedestal

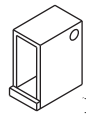

L-D

<b>L-D</b>	24	12	27 3/4	550	4.5	44
------------	----	----	--------	-----	-----	----

- For pull-out shelf Add 150
- For pocket door Add 200

End Panel



L-E

<b>L-E</b>	24	1 1/4	27 3/4	250	0.6	27
------------	----	-------	--------	-----	-----	----

Two Lateral File Drawers

36" <b>L-K</b>	24	36	27 3/4	1600	13.6	73
----------------	----	----	--------	------	------	----

Two Lateral File Drawers

30" <b>L-M</b>	24	30	27 3/4	1550	11.3	61
----------------	----	----	--------	------	------	----

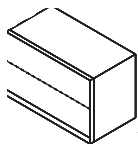

L-K

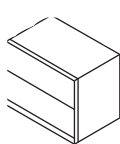

L-M

Swing Door Storage

18" <b>L-H</b>	24	18	27 3/4	800	6.8	44
----------------	----	----	--------	-----	-----	----

Double Swing Door Storage

30" <b>L-P</b>	24	30	27 3/4	1175	9.3	55
----------------	----	----	--------	------	-----	----

Double Swing Door Storage

36" <b>L-J</b>	24	36	27 3/4	1225	11.2	59
----------------	----	----	--------	------	------	----

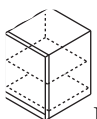

L-H

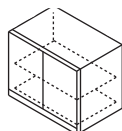

L-P

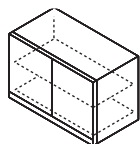

L-J

To be used within a Return or Credenza shell only.

Specify Model Number, Wood Finish, and Optional Accessories

30" Return and Credenza Shells

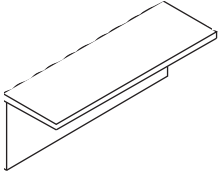

Model No.	Depth	Width	Height	Price	Add for Stone	Add for Leather	Cubic Feet	Weight
<b>E/RC-3018</b>	30	18	29	1825	1250	500	11.0	69
<b>E/RC-3024</b>	30	24	29	1950	1625	600	15.0	88
<b>E/RC-3030</b>	30	30	29	2075	2050	700	18.8	106
<b>E/RC-3036</b>	30	36	29	2250	2450	825	22.5	124
<b>E/RC-3042</b>	30	42	29	2675	2850	950	26.3	142
<b>E/RC-3048</b>	30	48	29	3050	3250	1100	30.0	160
<b>E/RC-3054</b>	30	54	29	3450	3675	1225	33.8	178
<b>E/RC-3060</b>	30	60	29	3800	4075	1350	37.5	196
<b>E/RC-3066</b>	30	66	29	4175	4475	1500	41.3	214
<b>E/RC-3072</b>	30	72	29	4575	4875	1625	45.0	232
<b>E/RC-3078</b>	30	78	29	4925	5300	1750	48.8	250
<b>E/RC-3084</b>	30	84	29	5325	5700	1925	52.5	268
<b>E/RC-3090</b>	30	90	29	5700	6100	2050	56.3	286
<b>E/RC-3096</b>	30	96	29	6475	6500	2175	60.0	304
<b>E/RC-30108</b>	30	108	29	7600	7325	2450	63.8	340
<b>E/RC-30120</b>	30	120	29	8725	8125	2725	67.5	376
<b>E/RC-30132</b>	30	132	29	9850	8950	2975	71.3	412
<b>E/RC-30144</b>	30	144	29	11000	9750	3250	75.0	448

CRT Corner Unit

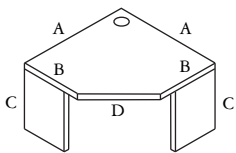

	A	B	C	D		
<b>E/CRT-4830</b>	48	30	25	29	4175	40.0 170
<b>E/CRT-5430</b>	54	30	34	29	4575	50.5 195

Includes 2 1/2" grommet

Specify Model Number, Wood Finish, Edge Detail and Optional Accessories

30" Return, Bridge and Credenza Shell Components

	Model No.	Depth	Width	Height	Price	Cubic Feet	Weight
Two File Drawers	<b>L-A</b>	30	18	27 3/4	1450	5.6	48
Two Box and File Drawers	<b>L-B</b>	30	18	27 3/4	1450	5.6	55

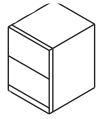

L-A



L-B

CPU Pedestal

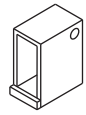

L-D

<b>L-D</b>	30	12	27 3/4	550	4.5	44
------------	----	----	--------	-----	-----	----

- For pull-out shelf Add 150
- For pocket door Add 200

End Panel



L-E

<b>L-E</b>	30	1 1/4	27 3/4	250	0.6	27
------------	----	-------	--------	-----	-----	----

Two Lateral File Drawers

36" <b>L-K</b>	30	36	27 3/4	1725	11.2	73
----------------	----	----	--------	------	------	----

Two Lateral File Drawers

30" <b>L-M</b>	30	30	27 3/4	1675	9.3	61
----------------	----	----	--------	------	-----	----

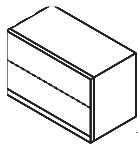

L-K

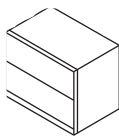

L-M

Swing Door Storage

18" <b>L-H</b>	30	18	27 3/4	925	5.6	44
----------------	----	----	--------	-----	-----	----

Double Swing Door Storage

30" <b>L-P</b>	30	30	27 3/4	1325	9.3	55
----------------	----	----	--------	------	-----	----

Double Swing Door Storage

36" <b>L-J</b>	30	36	27 3/4	1350	11.2	59
----------------	----	----	--------	------	------	----

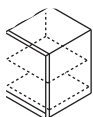

L-H

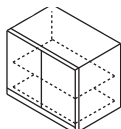

L-P

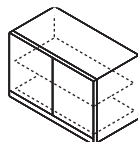

L-J

To be used within a Return or Credenza shell only.

Specify Model Number, Wood Finish, and Optional Accessories

Workstations

Kneespace Credenza  
W/Hutch

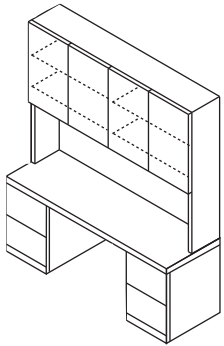

Model No.	Depth	Width	Height	Price
<b>E/WS-2472-20</b>				9825
Credenza	24	72	29	
Hutch	15	72	54	
<b>E/WS-2478-20</b>				10300
Credenza	24	78	29	
Hutch	15	78	54	
<b>E/WS-2484-20</b>				10750
Credenza	24	84	29	
Hutch	15	84	54	

No Tack Panel.  
No Task Light.

Credenza Workstation

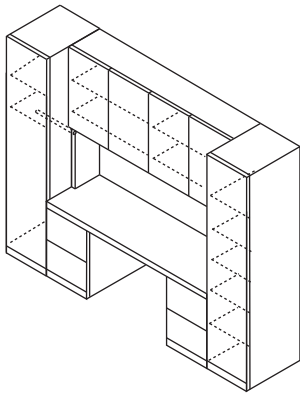

<b>E/WS-24108-21</b>				16175
Credenza	24	72	29	
Hutch	15	72	54	
WSM-83-W	24	18	83	
WSM-83-X	24	18	83	
<b>E/WS-24120-21</b>				17100
Credenza	24	84	29	
Hutch	15	84	54	
WSM-83-W	24	18	83	
WSM-83-X	24	18	83	

No Tack Panel.  
No Task Light.

Credenza Workstation

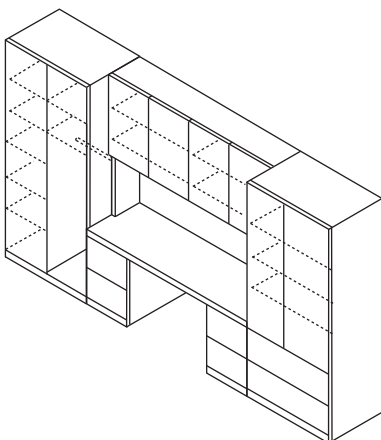

<b>E/WS-24144-22</b>				19250
Credenza	24	72	29	
Hutch	15	72	54	
WSM-83-R	24	36	83	
WSM-83-T	24	36	83	
<b>E/WS-24156-22</b>				20200
Credenza	24	84	29	
Hutch	15	84	54	
WSM-83-R	24	36	83	
WSM-83-T	24	36	83	

No Tack Panel.  
No Task Light.

Specify Model Number, Wood Finish, Edge Detail and Optional Accessories

Model No.	Depth	Width	Height	Price	Cubic Feet	Weight
<b>Kneespace Credenza W/Hutch</b>				<b>E/WS-2472-10</b>	8950	53.0 430
	Credenza	24	72	29		
	Hutch	15	72	41		
				<b>E/WS-2478-10</b>	9375	57.4 450
	Credenza	24	78	29		
	Hutch	15	78	41		
				<b>E/WS-2484-10</b>	9825	61.8 480
	Credenza	24	84	29		
	Hutch	15	84	41		

No Tack Panel.  
No Task Light.

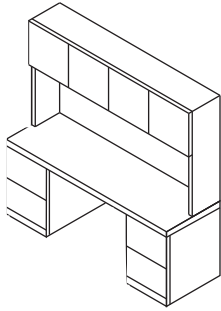

<b>Credenza Workstation</b>				<b>E/WS-24108-11</b>	14300	88.0 820
	Credenza	24	72	29		
	Hutch	15	72	41		
	WSM-70-W	24	18	70		
	WSM-70-X	24	18	70		
				<b>E/WS-24120-11</b>	15175	96.8 870
	Credenza	24	84	29		
	Hutch	15	84	41		
	WSM-70-W	24	18	70		
	WSM-70-X	24	18	70		

No Tack Panel.  
No Task Light.

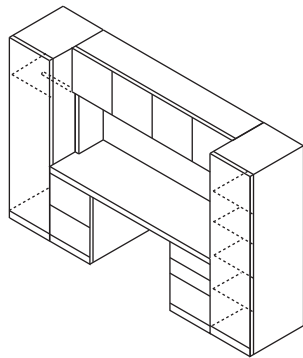

<b>Credenza Workstation</b>				<b>E/WS-24144-12</b>	16925	123.0 1125
	Credenza	24	72	29		
	Hutch	15	72	41		
	WSM-70-R	24	36	70		
	WSM-70-T	24	36	70		
				<b>E/WS-24156-12</b>	17800	131.8 1175
	Credenza	24	84	29		
	Hutch	15	84	41		
	WSM-70-R	24	36	70		
	WSM-70-T	24	36	70		

No Tack Panel.  
No Task Light.

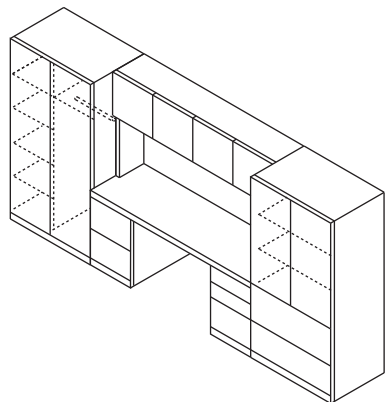

Workstation Components

Wardrobe

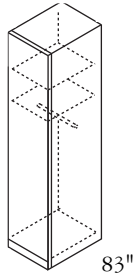
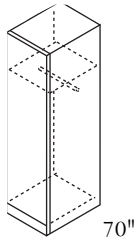

**E/WSM-70-W(R or L)**

Model No.	Depth	Width	Height	Price	Cubic Feet	Weight
E/WSM-70-W(R or L)	24	18	70	2600	17.5	190

**E/WSM-83-W(R or L)**

E/WSM-83-W(R or L)	24	18	83	3100	20.8	215
--------------------	----	----	----	------	------	-----

Specify: (R)ight if hinge is on right  
(L)eft if hinge is on left

Storage

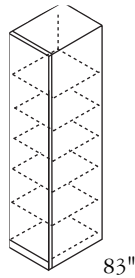
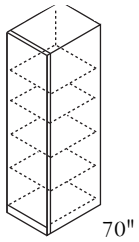

**E/WSM-70-X(R or L)**

E/WSM-70-X(R or L)	24	18	70	2750	17.5	200
--------------------	----	----	----	------	------	-----

**E/WSM-83-X(R or L)**

E/WSM-83-X(R or L)	24	18	83	3250	20.8	225
--------------------	----	----	----	------	------	-----

Specify: (R)ight if hinge is on right  
(L)eft if hinge is on left

Storage/File

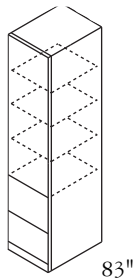
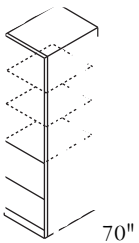

**E/WSM-70-Y(R or L)**

E/WSM-70-Y(R or L)	24	18	70	3325	17.5	210
--------------------	----	----	----	------	------	-----

**E/WSM-83-Y(R or L)**

E/WSM-83-Y(R or L)	24	18	83	3950	20.8	235
--------------------	----	----	----	------	------	-----

Specify: (R)ight if hinge is on right  
(L)eft if hinge is on left

Wardrobe/Storage

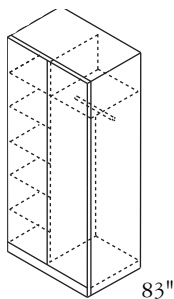
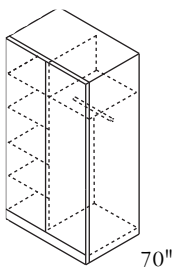

**E/WSM-70-R**

E/WSM-70-R	24	36	70	3625	35.0	340
------------	----	----	----	------	------	-----

**E/WSM-83-R**

E/WSM-83-R	24	36	83	4325	41.5	375
------------	----	----	----	------	------	-----

Storage

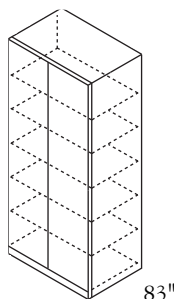
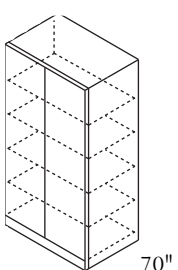

**E/WSM-70-S**

E/WSM-70-S	24	36	70	3750	35.0	345
------------	----	----	----	------	------	-----

**E/WSM-83-S**

E/WSM-83-S	24	36	83	4475	41.5	380
------------	----	----	----	------	------	-----

Specify Model Number, Wood Finish, and Optional Accessories

Workstation Components

Storage/Lateral File

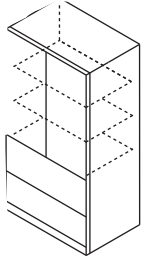

70"

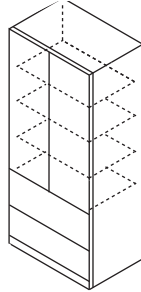

83"

Model No.	Depth	Width	Height	Price	Cubic Feet	Weight
<b>E/WSM-70-T</b>	24	36	70	4350	35.0	355
<b>E/WSM-83-T</b>	24	36	83	5125	41.5	390

Storage/4-High Lateral File

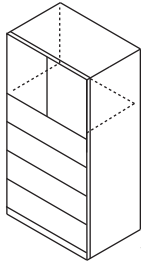

70"

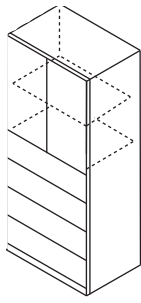

83"

<b>E/WSM-70-N</b>	24	36	70	5075	35.0	375
<b>E/WSM-83-N</b>	24	36	83	5625	41.5	410

COM Yardage

Presentation Board

Magnetic white board center with tackable fabric inside doors.

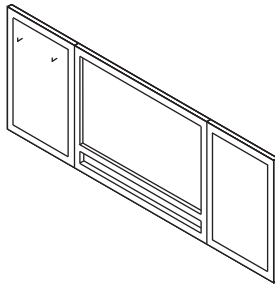

<b>E/PB-4836</b>	3	48	36	2475	1 2/3	3.0	120
<b>E/PB-4848</b>	3	48	48	2750	1 2/3	4.0	160
<b>E/PB-6048</b>	3	60	48	3050	2	5.0	200
<b>E/PB-7248</b>	3	72	48	3475	2 1/3	6.0	240

- Pull-down Projection Screen: Add 400
- Fabric: Maharam

Audio Visual Unit

With pocket doors and internal wire management.

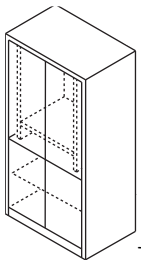

70"

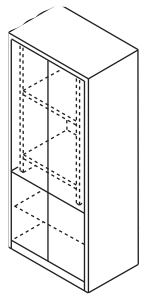

83"

<b>E/AV-3670-1</b>	24	36	70	5500	35.0	355
<b>E/AV-3683-1</b>	24	36	83	6350	41.5	390

- Pull-out and Swivel: Add 400
- Video Cassette Drawer: Add 300
- Six outlet plug strip with surge protector: Add 85

Specify Model Number, Wood Finish, Fabric Selection, and Optional Accessories

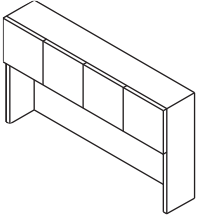
	Model No.	Depth	Width	Height	Price	Cubic Feet	Weight
<p>Hutch With Doors</p> 	<b>E/H-6041-D</b>	15	60	41	2675	20.0	200
	<b>E/H-6641-D</b>	15	66	41	2750	22.0	215
	<b>E/H-7241-D</b>	15	72	41	2850	24.0	215
	<b>E/H-7841-D</b>	15	78	41	3000	26.0	215

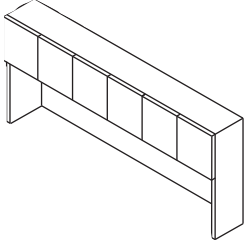
<p>Hutch With Doors</p> 	<b>E/H-8441-D</b>	15	84	41	3175	26.0	215
	<b>E/H-9041-D</b>	15	90	41	3300	29.8	245
	<b>E/H-9641-D</b>	15	96	41	3450	31.8	260
	<b>E/H-10841-D</b>	15	108	41	3725	35.8	290

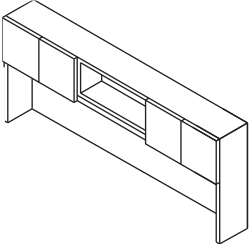
<p>Hutch Open Center</p> 	<b>E/H-8441-1</b>	15	84	41	2950	28.0	230
	<b>E/H-9041-1</b>	15	90	41	3075	29.8	240
	<b>E/H-9641-1</b>	15	96	41	3225	31.8	250
	<b>E/H-10241-1</b>	15	102	41	3350	33.8	260
	<b>E/H-10841-1</b>	15	108	41	3500	35.8	270
	<b>E/H-11441-1</b>	15	114	41	3925	37.8	280
	<b>E/H-12041-1</b>	15	120	41	4325	39.8	300

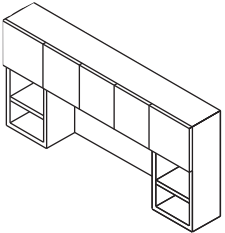
<p>Hutch With Side Towers</p> 	<b>E/H-7241-2</b>	15	72	41	3575	24.0	300
	<b>E/H-7841-2</b>	15	78	41	3725	26.0	315
	<b>E/H-8441-2</b>	15	84	41	3875	30.6	330
	<b>E/H-9041-2</b>	15	90	41	4000	32.8	345
	<b>E/H-9641-2</b>	15	96	41	4175	34.2	360
	<b>E/H-10241-2</b>	15	102	41	4450	36.3	375
	<b>E/H-10841-2</b>	15	108	41	4600	38.4	390
	<b>E/H-12041-2</b>	15	120	41	4875	42.7	420

Specify Model Number, Wood Finish, and Optional Accessories

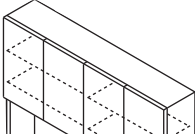
	Model No.	Depth	Width	Height	Price	Cubic Feet	Weight
<p>Hutch With Doors</p> 	<b>E/H-6054-D</b>	15	60	54	3475	27.1	200
	<b>E/H-6654-D</b>	15	66	54	3600	29.8	340
	<b>E/H-7254-D</b>	15	72	54	3725	32.5	370
	<b>E/H-7854-D</b>	15	78	54	3925	35.2	400

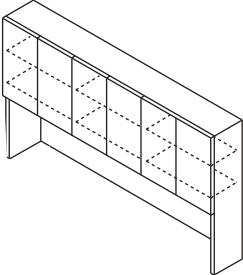
<p>Hutch With Doors</p> 	<b>E/H-8454-D</b>	15	84	54	4100	37.9	415
	<b>E/H-9054-D</b>	15	90	54	4250	40.6	460
	<b>E/H-9654-D</b>	15	96	54	4450	43.3	485
	<b>E/H-10854-D</b>	15	108	54	4825	48.7	530
	<b>E/H-11454-D</b>	15	114	54	5200	51.5	545
	<b>E/H-12054-D</b>	15	120	54	5600	54.2	565

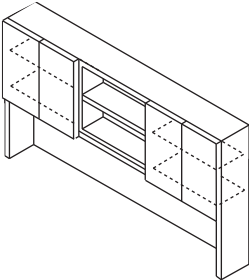
<p>Hutch Open Center</p> 	<b>E/H-8454-OC</b>	15	84	54	3825	37.9	410
	<b>E/H-9054-OC</b>	15	90	54	4000	40.6	450
	<b>E/H-9654-OC</b>	15	96	54	4200	45.3	485
	<b>E/H-10254-OC</b>	15	102	54	4375	46.0	505
	<b>E/H-10854-OC</b>	15	108	54	4575	48.7	525
	<b>E/H-11454-OC</b>	15	114	54	4950	51.5	545
	<b>E/H-12054-OC</b>	15	120	54	5350	54.2	565

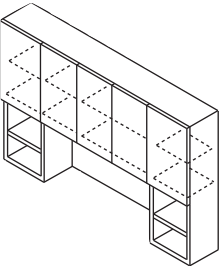
<p>Hutch With Side Towers</p> 	<b>E/H-7254-ST</b>	15	72	54	4600	32.5	360
	<b>E/H-7854-ST</b>	15	78	54	4800	35.2	380
	<b>E/H-8454-ST</b>	15	84	54	4950	37.9	410
	<b>E/H-9054-ST</b>	15	90	54	5125	40.6	450
	<b>E/H-9654-ST</b>	15	96	54	5325	45.3	485
	<b>E/H-10254-ST</b>	15	102	54	5625	47.8	505
	<b>E/H-10854-ST</b>	15	108	54	5825	50.6	525
	<b>E/H-12054-ST</b>	15	120	54	6125	56.3	545

Specify Model Number, Wood Finish, and Optional Accessories

	Model No.	Depth	Width	Height	Price	Cubic Feet	Weight
Hutch Open	<b>E/H-7241-O</b>	14	72	41	2425	24.0	180
	<b>E/H-7841-O</b>	14	78	41	2575	26.0	192

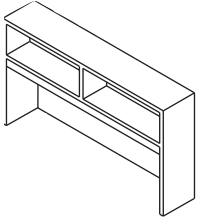

Hutch Open	<b>E/H-8441-O</b>	14	84	41	2575	26.0	204
	<b>E/H-9041-O</b>	14	90	41	2725	29.8	216
	<b>E/H-9641-O</b>	14	96	41	2850	34.2	228
	<b>E/H-10241-O</b>	14	102	41	3000	37.8	234
	<b>E/H-10841-O</b>	14	108	41	3175	42.2	246
	<b>E/H-11441-O</b>	14	114	41	3300	46.4	258
	<b>E/H-12041-O</b>	14	120	41	3475	50.0	270

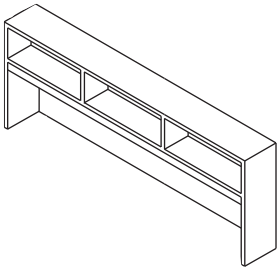

Hutch Open	<b>E/H-7254-O</b>	14	72	54	3225	32.5	328
	<b>E/H-7854-O</b>	14	78	54	3425	35.2	356

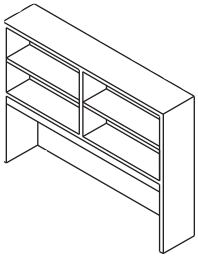

Hutch Open	<b>E/H-8454-O</b>	14	84	54	3325	37.9	384
	<b>E/H-9054-O</b>	14	90	54	3500	40.6	412
	<b>E/H-9654-O</b>	14	96	54	3700	43.3	440
	<b>E/H10254-O</b>	14	102	54	3875	47.8	468
	<b>E/H-10854-O</b>	14	108	54	4050	50.6	496
	<b>E/H-11454-O</b>	14	114	54	4250	53.4	524
	<b>E/H-12054-O</b>	14	120	54	4700	56.3	552

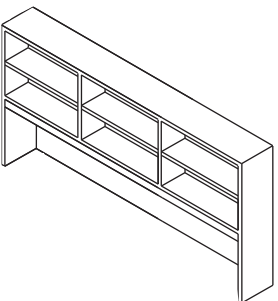

Specify Model Number, Wood Finish, and Optional Accessories

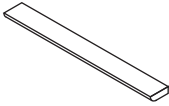
	Model No.	Depth	Width	Height	Price		Cubic Feet	Weight
Task Lighting 	<b>E/TL-24</b>	6	24	2	300		0.1	7
	<b>E/TL-36</b>	6	36	2	350		0.2	10
	<b>E/TL-48</b>	6	48	2	400		0.3	13
	<b>E/TL-60</b>	6	60	2	450		0.4	20

COM Yardage

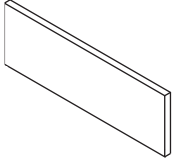
Tack Panels 	<b>E/TP-2430</b>	1	30	24	325	1	.4	4
	<b>E/TP-2436</b>	1	36	24	350	1 1/3	.5	4
	<b>E/TP-2442</b>	1	42	24	375	1 1/3	.6	6
	<b>E/TP-2448</b>	1	48	24	375	1 1/2	.7	8
	<b>E/TP-2454</b>	1	54	24	400	1 2/3	.9	10
	<b>E/TP-2460</b>	1	60	24	425	2	1.2	12
	<b>E/TP-2466</b>	1	66	24	450	2	1.5	14
	<b>E/TP-2472</b>	1	72	24	475	2 1/3	1.8	16
	<b>E/TP-2478</b>	1	78	24	500	2 1/3	2.1	18
	<b>E/TP-2484</b>	1	84	24	525	2 1/2	2.4	20
	<b>E/TP-2490</b>	1	90	24	525	2 2/3	2.7	22
	<b>E/TP-2496</b>	1	96	24	550	2 3/4	3.0	24
	<b>E/TP-24102</b>	1	102	24	600	3	3.3	26
	<b>E/TP-24108</b>	1	108	24	625	3 1/4	3.6	28
<b>E/TP-24114</b>	1	114	24	675	3 1/4	3.9	30	
<b>E/TP-24120</b>	1	120	24	700	3 1/2	4.2	32	

- Tackpanels are one-piece unless otherwise specified
- Fabric: Maharam

Specify Model Number and Fabric Selection

	Model No.	Depth	Width	Height	Price	Cubic Feet	Weight
Wall Hung Overhead Storage W/Doors	<b>E/OS-3017-D</b>	15	30	17	1375	4.7	75
	<b>E/OS-3617-D</b>	15	36	17	1450	5.2	90

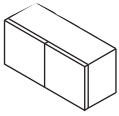

Wall Hung Overhead Storage W/Doors	<b>E/OS-4217-D</b>	15	42	17	1575	5.7	105
	<b>E/OS-4817-D</b>	15	48	17	1700	6.2	120
	<b>E/OS-5417-D</b>	15	54	17	1850	6.7	135

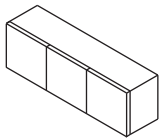

Wall Hung Overhead Storage W/Doors	<b>E/OS-6017-D</b>	15	60	17	2050	9.4	150
	<b>E/OS-6617-D</b>	15	66	17	2250	9.9	165
	<b>E/OS-7217-D</b>	15	72	17	2475	10.4	180
	<b>E/OS-7817-D</b>	15	78	17	2700	11.3	195

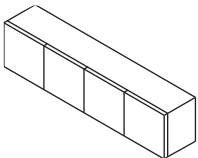

Wall Hung Overhead Storage W/Doors	<b>E/OS-8417-D</b>	15	84	17	2975	12.4	210
	<b>E/OS-9017-D</b>	15	90	17	3200	13.3	225
	<b>E/OS-9617-D</b>	15	96	17	3425	14.2	240
	<b>E/OS-10217-D</b>	15	102	17	3550	15.1	255

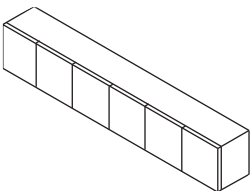

Wall Hung Overhead Storage W/Doors	<b>E/OS-10817-D</b>	15	108	17	3700	16.0	270
	<b>E/OS-11417-D</b>	15	114	17	3875	16.9	285
	<b>E/OS-12017-D</b>	15	120	17	4050	17.8	300

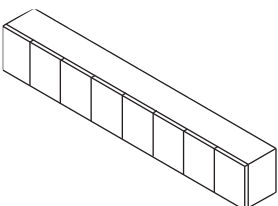

Wall hung overhead storage cabinets are supplied with a mounting cleat. It is the purchaser's responsibility to securely mount this cabinet.

Specify Model Number, Wood Finish, and Optional Accessories

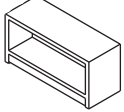
	Model No.	Depth	Width	Height	Price	Cubic Feet	Weight
Wall Hung Overhead Storage Open  	<b>E/OS-3017-O</b>	14	30	17	1175	4.7	75
	<b>E/OS-3617-O</b>	14	36	17	1225	5.2	90
	<b>E/OS-4217-O</b>	14	42	17	1375	6.2	105
	<b>E/OS-4817-O</b>	14	48	17	1550	7.1	120
	<b>E/OS-5417-O</b>	14	54	17	1675	8.0	135

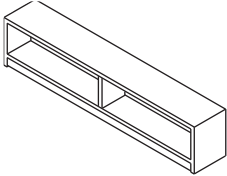
Wall Hung Overhead Storage Open  	<b>E/OS-6017-O</b>	14	60	17	1850	8.9	105
	<b>E/OS-6617-O</b>	14	66	17	2075	9.8	90
	<b>E/OS-7217-O</b>	14	72	17	2250	10.7	105
	<b>E/OS-7817-O</b>	14	78	17	2450	11.6	120
	<b>E/OS-8417-D</b>	14	84	17	2625	12.4	135
	<b>E/OS-9017-O</b>	14	90	17	2850	13.3	120
	<b>E/OS-9617-O</b>	14	96	17	3050	14.2	135

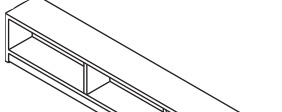
Wall Hung Overhead Storage Open  	<b>E/OS-10217-O</b>	14	102	17	3200	15.1	150
	<b>E/OS-10817-O</b>	14	108	17	3325	16.0	165
	<b>E/OS-11417-O</b>	14	114	17	3550	16.9	180
	<b>E/OS-12017-O</b>	14	120	17	3725	17.8	195

Wall hung overhead storage cabinets are supplied with a mounting cleat. It is the purchaser's responsibility to securely mount this cabinet.

Specify Model Number, Wood Finish, and Optional Accessories

	Model No.	Depth	Width	Height	Price	Cubic Feet	Weight
Wall Hung Overhead Storage W/Doors	<b>E/OS-3030-D</b>	15	30	30	1700	7.8	150
	<b>E/OS-3630-D</b>	15	36	30	1850	9.4	180

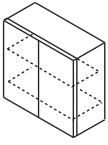

Wall Hung Overhead Storage W/Doors	<b>E/OS-4230-D</b>	15	42	30	2050	11.0	210
	<b>E/OS-4830-D</b>	15	48	30	2250	12.5	240
	<b>E/OS-5430-D</b>	15	54	30	2475	14.1	270

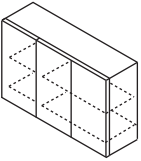

Wall Hung Overhead Storage W/Doors	<b>E/OS-6030-D</b>	15	60	30	2750	15.7	290
	<b>E/OS-6630-D</b>	15	66	30	3050	17.3	310
	<b>E/OS-7230-D</b>	15	72	30	3325	18.8	330
	<b>E/OS-7830-D</b>	15	78	30	3625	20.3	350

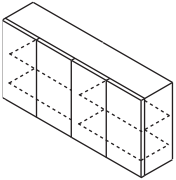

Wall Hung Overhead Storage W/Doors	<b>E/OS-8430-D</b>	15	84	30	4050	21.9	370
	<b>E/OS-9030-D</b>	15	90	30	4350	23.5	390
	<b>E/OS-9630-D</b>	15	96	30	4625	25.1	410
	<b>E/OS-10230-D</b>	15	102	30	4925	26.6	430

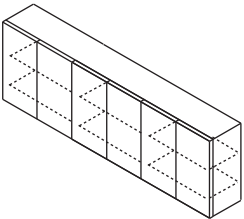

Wall Hung Overhead Storage W/Doors	<b>E/OS-10830-D</b>	15	108	30	5350	28.2	450
	<b>E/OS-11430-D</b>	15	114	30	5625	29.7	470
	<b>E/OS-12030-D</b>	15	120	30	5500	31.3	490

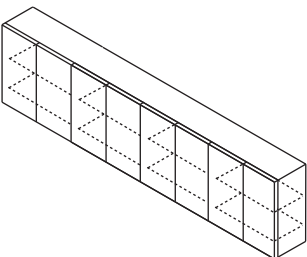

Wall hung overhead storage cabinets are supplied with a mounting cleat. It is the purchaser's responsibility to securely mount this cabinet.

Specify Model Number, Wood Finish, and Optional Accessories

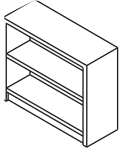
	Model No.	Depth	Width	Height	Price	Cubic Feet	Weight
Wall Hung Overhead Storage Open  	<b>E/OS-3017-O</b>	14	30	30	1450	7.8	140
	<b>E/OS-3630-O</b>	14	36	30	1600	9.4	170
	<b>E/OS-4230-O</b>	14	42	30	1725	11.0	200
	<b>E/OS-4830-O</b>	14	48	30	1925	12.5	230
	<b>E/OS-5430-O</b>	14	54	30	2125	14.1	260

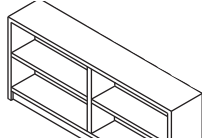
Wall Hung Overhead Storage Open  	<b>E/OS-6030-O</b>	14	60	30	2350	15.7	280
	<b>E/OS-6630-O</b>	14	66	30	2575	17.3	300
	<b>E/OS-7230-O</b>	14	72	30	2800	18.8	320
	<b>E/OS-7830-O</b>	14	78	30	3000	20.3	340

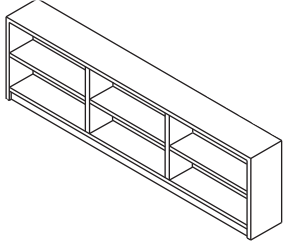
Wall Hung Overhead Storage Open  	<b>E/OS-8430-O</b>	14	84	30	3225	21.9	360
	<b>E/OS-9030-O</b>	14	90	30	3450	23.5	380
	<b>E/OS-9630-O</b>	14	96	30	3675	25.1	400
	<b>E/OS-10230-O</b>	14	102	30	4050	26.6	420
	<b>E/OS-10830-O</b>	14	108	30	4250	28.2	440
	<b>E/OS-11430-O</b>	14	114	30	4475	29.7	460
	<b>E/OS-12030-O</b>	14	120	30	4700	31.3	480

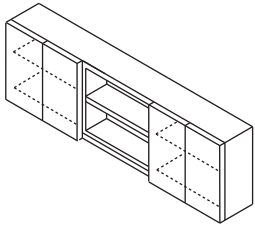
Wall Hung Overhead Storage Open Center  	<b>E/OS-9630-OC</b>	15	96	30	4375	25.1	390
	<b>E/OS-10830-OC</b>	15	108	30	5075	28.2	430
	<b>E/OS-12030-OC</b>	15	120	30	5225	31.3	470

Wall hung overhead storage cabinets are supplied with a mounting cleat. It is the purchaser's responsibility to securely mount this cabinet.

Specify Model Number, Wood Finish, and Optional Accessories

Reception Desks

The following pages contain the components necessary to specify custom configurations of L-Desks, U-Desks and Credenzas. Find the desired size of desk, return and/or credenza shells and add the pedestals as required.

Pricing Examples

Credenza

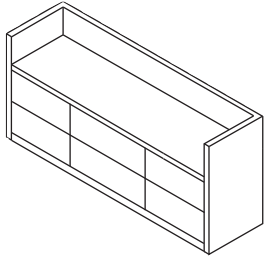

Description:	Price
Credenza consisting of the following:	
E/RCS-2490 Credenza Shell	4200
(3) L-M Lateral File Pedestals	<u>4275</u>
Total Price	8475

L-Desk

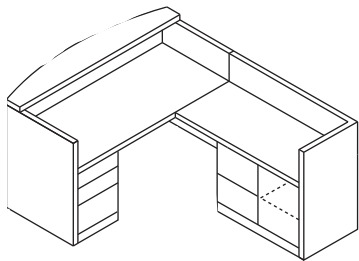

Description:	Price
L-Desk consisting of the following:	
E/RDS/B-3678(L-3) Bow Front Desk	7850
E/RRS-2454 Return Shell	2975
L-H Swing Door Storage Pedestal	725
L-A File/File Pedestal	<u>1225</u>
Total Price	12775

U-Desk

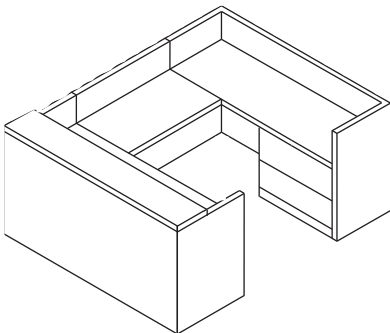

Description:	Price
U-Desk consisting of the following:	
E/RDS/R-3084(L-3) Rectangular Desk	7725
E/RBS-2454 Return Shell	2625
E/RCS-2484 Credenza Shell	3875
L-K Lateral File Pedestal	<u>1475</u>
Total Price	15700

Desk Pedestals L-2 and L-3 can be interchanged without affecting price.

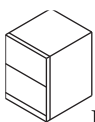

L-2

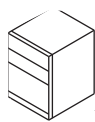

L-3

Specify Model Number, Wood Finish, Edge Detail and Optional Accessories

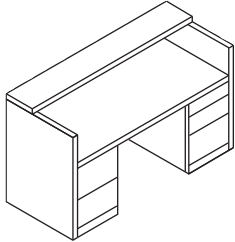
	Model No.	Depth	Width	Height	Price	Add for Stone Guest Ledge	Cubic Feet	Weight
<p>Double Pedestal Reception Desk</p> 	<b>E/RD/R-3072</b>	30	72	42	9225	1800	52.4	370
	<b>E/RD/R-3078</b>	30	78	42	9500	1975	56.8	410
	<b>E/RD/R-3084</b>	30	84	42	9800	2100	61.2	450
	<b>E/RD/R-3096</b>	30	96	42	10350	2400	69.9	530

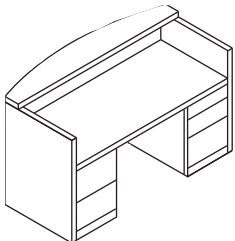
<p>Bow Front Double Pedestal Reception Desk</p> 	<b>E/RD/B-3672</b>	36	72	42	9675	2000	52.4	370
	<b>E/RD/B-3678</b>	36	78	42	9950	2175	56.8	410
	<b>E/RD/B-3684</b>	36	84	42	10225	2350	61.2	450
	<b>E/RD/B-3696</b>	36	96	42	10750	3450	69.9	530

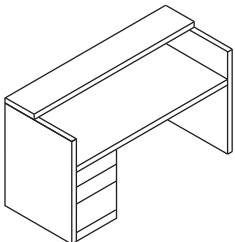
<p>Single Pedestal Reception Desk</p> 	<b>E/RDS/R-3072</b>	30	72	42	7850	1800	52.4	320
	<b>E/RDS/R-3078</b>	30	78	42	8175	1975	56.8	360
	<b>E/RDS/R-3084</b>	30	84	42	8450	2100	61.2	400
	<b>E/RDS/R-3096</b>	30	96	42	8975	2400	69.9	480

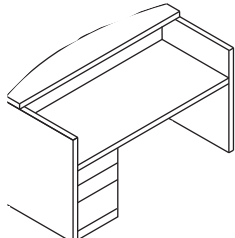
<p>Bow Front Single Pedestal Reception Desk</p> 	<b>E/RDS/B-3672</b>	36	72	42	8300	2000	52.4	320
	<b>E/RDS/B-3678</b>	36	78	42	8550	2175	56.8	360
	<b>E/RDS/B-3684</b>	36	84	42	8875	2350	61.2	400
	<b>E/RDS/B-3696</b>	36	96	42	9450	3450	69.9	480

Specify Model Number, Wood Finish, Edge Detail and Optional Accessories

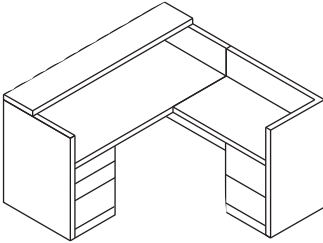
Model No.	Depth	Width	Height	Price	Add for Stone Guest Ledge	Cubic Feet	Weight
<b>Reception L-Desk</b>							
Right return shown, specify (R)ight or (L)eft							
	<b>E/RL-7272-R(R or L)</b>			11850	1950	76.8	470
	Desk	30	72	42			
	Return	24	42	42			
	<b>E/RL-7872-R(R or L)</b>			12175	2125	80.2	510
	Desk	30	78	42			
	Return	24	42	42			
	<b>E/RL-8472-R(R or L)</b>			12450	2300	85.6	550
	Desk	30	84	42			
	Return	24	42	42			

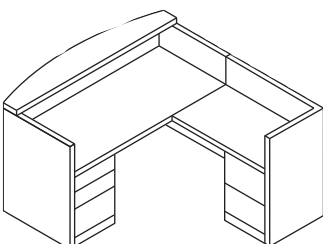
<b>Bow Front Reception L-Desk</b>							
Right return shown, specify (R)ight or (L)eft							
	<b>E/RL-7278-B(R or L)</b>			12300	2175	76.8	470
	Desk	36	72	42			
	Return	24	42	42			
	<b>E/RL-7878-B(R or L)</b>			12550	2350	80.2	510
	Desk	36	78	42			
	Return	24	42	42			
	<b>E/RL-8478-B(R or L)</b>			12875	2550	85.6	550
	Desk	36	84	42			
	Return	24	42	42			

Specify Model Number, Wood Finish, Edge Detail and Optional Accessories

Reception U-Desk  
Right return shown, specify (R)ight or (L)eft

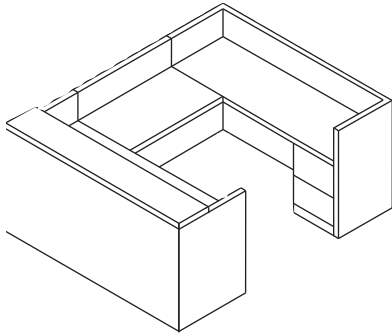

Model No.	Depth	Width	Height	Price	Add for Stone Guest Ledge	Cubic Feet	Weight
<b>E/RU-7296-R(R or L)</b>				14950	1950	118.7	670
Desk/Credenza	30/24	72	42				
Return	24	42	42				
<b>E/RU-7896-R(R or L)</b>				15600	2125	122.1	735
Desk/Credenza	30/24	78	42				
Return	24	42	42				
<b>E/RU-8496-R(R or L)</b>				16250	2300	127.5	800
Desk/Credenza	30/24	84	42				
Return	24	42	42				

Bow Front Reception U-Desk  
Right return shown, specify (R)ight or (L)eft

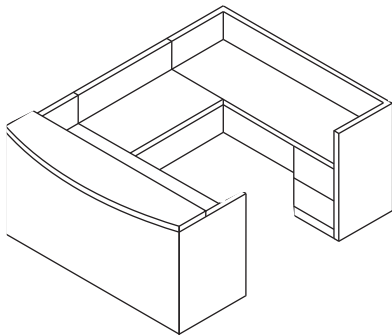

<b>E/RU-72102-B(R or L)</b>				15375	2175	118.7	670
Desk/Credenza	36/24	72	42				
Return	24	42	42				
<b>E/RU-78102-B(R or L)</b>				15975	2350	122.1	735
Desk/Credenza	36/24	78	42				
Return	24	42	42				
<b>E/RU-84102-B(R or L)</b>				16700	2550	127.5	800
Desk/Credenza	36/24	84	42				
Return	24	42	42				

Specify Model Number, Wood Finish, Edge Detail and Optional Accessories

21" Reception Desk Shells

Return Shell  
Right shown, specify (R)ight or (L)eft

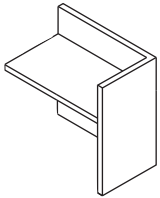

Model No.	Depth	Width	Height	Price	Cubic Feet	Weight
<b>E/RRS-2142(R or L)</b>	21	42	42	2500	21.5	100
<b>E/RRS-2148(R or L)</b>	21	48	42	2725	24.5	105
<b>E/RRS-2154(R or L)</b>	21	54	42	3050	27.5	110

Bridge  
Right shown, specify (R)ight or (L)eft

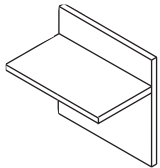

<b>E/RBS-2142(R or L)</b>	21	42	42	2075	21.5	85
<b>E/RBS-2148(R or L)</b>	21	48	42	2325	24.5	90
<b>E/RBS-2154(R or L)</b>	21	54	42	2625	27.5	95

Credenza

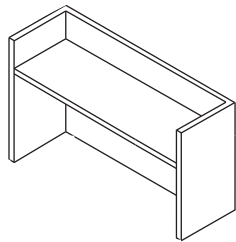

<b>E/RCS-2172</b>	21	72	42	3300	36.8	171
<b>E/RCS-2178</b>	21	78	42	3625	39.8	195
<b>E/RCS-2184</b>	21	84	42	3975	43.0	228
<b>E/RCS-2196</b>	21	96	42	4375	49.0	263

Specify Model Number, Wood Finish, Edge Detail and Optional Accessories

21" Return, Bridge and Credenza Shell Components

	Model No.	Depth	Width	Height	Price	Cubic Feet	Weight
Two File Drawers	<b>L-A</b>	21	18	27 3/4	1175	5.6	43
Two Box and File Drawers	<b>L-B</b>	21	18	27 3/4	1175	5.6	50

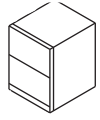

L-A

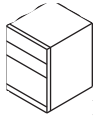

L-B

CPU Pedestal

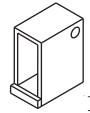

L-D

<b>L-D</b>	21	12	27 3/4	550	4.5	44
------------	----	----	--------	-----	-----	----

- For pull-out shelf Add 150
- For pocket door Add 200

Two Lateral File Drawers

36" <b>L-K</b>	21	36	27 3/4	1450	11.2	68
----------------	----	----	--------	------	------	----

Two Lateral File Drawers

30" <b>L-M</b>	21	30	27 3/4	1375	9.3	57
----------------	----	----	--------	------	-----	----

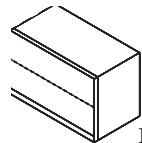

L-K

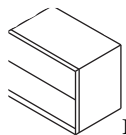

L-M

Swing Door Storage

18" <b>L-H</b>	21	18	27 3/4	700	5.6	39
----------------	----	----	--------	-----	-----	----

Double Swing Door Storage

30" <b>L-P</b>	21	30	27 3/4	1075	9.3	55
----------------	----	----	--------	------	-----	----

Double Swing Door Storage

36" <b>L-J</b>	21	36	27 3/4	1125	11.2	59
----------------	----	----	--------	------	------	----

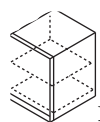

L-H

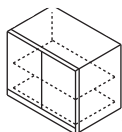

L-P

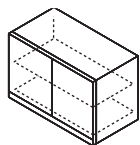

L-J

To be used within a Return or Credenza shell only.

Specify Model Number, Wood Finish, and Optional Accessories

24" Reception Desk Shells

Return Shell  
Right shown, specify (R)ight or (L)eft

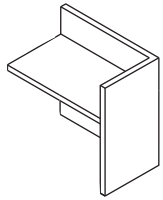

Model No.	Depth	Width	Height	Price	Cubic Feet	Weight
<b>E/RRS-2442(R or L)</b>	24	42	42	2700	24.5	105
<b>E/RRS-2448(R or L)</b>	24	48	42	2875	28.0	110
<b>E/RRS-2454(R or L)</b>	24	54	42	3225	31.5	115

Bridge  
Right shown, specify (R)ight or (L)eft

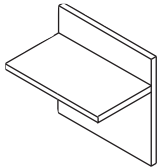

<b>E/RBS-2442(R or L)</b>	24	42	42	2325	24.5	90
<b>E/RBS-2448(R or L)</b>	24	48	42	2575	28.0	95
<b>E/RBS-2454(R or L)</b>	24	54	42	2850	31.5	100

Credenza

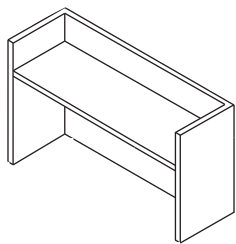

<b>E/RCS-2472</b>	24	72	42	3475	42.0	171
<b>E/RCS-2478</b>	24	78	42	3825	45.5	195
<b>E/RCS-2484</b>	24	84	42	4200	49.0	228
<b>E/RCS-2496</b>	24	96	42	4975	56.0	263

Specify Model Number, Wood Finish, Edge Detail and Optional Accessories

24" Reception Desk Components

	Model No.	Depth	Width	Height	Price	Cubic Feet	Weight
Two File Drawers	<b>L-A</b>	24	18	27 3/4	1325	5.6	43
Two Box and File Drawers	<b>L-B</b>	24	18	27 3/4	1325	5.6	50

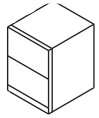

L-A

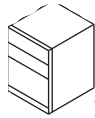

L-B

CPU Pedestal

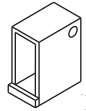

L-D

<b>L-D</b>	24	12	27 3/4	550	4.5	44
------------	----	----	--------	-----	-----	----

- For pull-out shelf Add 150
- For pocket door Add 200

Two Lateral File Drawers

36" <b>L-K</b>	24	36	27 3/4	1600	11.2	68
----------------	----	----	--------	------	------	----

Two Lateral File Drawers

30" <b>L-M</b>	24	30	27 3/4	1550	9.3	57
----------------	----	----	--------	------	-----	----

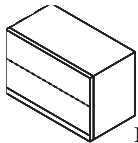

L-K

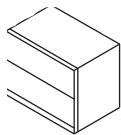

L-M

Swing Door Storage

18" <b>L-H</b>	24	18	27 3/4	800	5.6	39
----------------	----	----	--------	-----	-----	----

Double Swing Door Storage

30" <b>L-P</b>	24	30	27 3/4	1175	9.3	55
----------------	----	----	--------	------	-----	----

Double Swing Door Storage

36" <b>L-J</b>	24	36	27 3/4	1225	11.2	59
----------------	----	----	--------	------	------	----

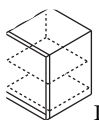

L-H

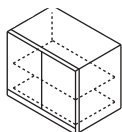

L-P

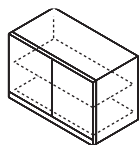

L-J

To be used within a Return or Credenza shell only.

Specify Model Number, Wood Finish, and Optional Accessories

Race Track Oval  
Conference Tables

Veneer Top

Add For  
Stone Top

42 x 84

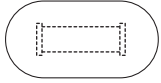

Seating capacity of 6  
Grain direction

Model No.	<b>E/CT-4284-RTO</b>	
Price	6350	8500
Weight	245	721
	1 piece top/2 panel bases	

48 x 96

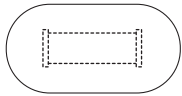

Seating capacity of 8  
Grain direction

Model No.	<b>E/CT-4896-RTO</b>	
Price	9075	11100
Weight	302	827
	1 piece top/2 panel bases	

48 x 120

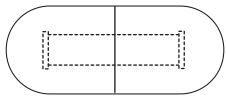

Seating capacity of 10  
Grain direction

Model No.	<b>E/CT-48120-RTO</b>	
Price	10375	13875
Weight	355	929
	2 piece top/2 panel bases	

48 x 144

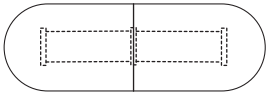

Seating capacity of 12  
Grain direction

Model No.	<b>E/CT-48144-RTO</b>	
Price	13500	16675
Weight	401	1009
	2 piece top/3 panel bases	

54 x 168

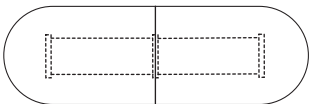

Seating capacity of 14  
Grain direction

Model No.	<b>E/CT-54168-RTO</b>	
Price	15475	21850
Weight	525	1169
	2 piece top/3 panel bases	

54 x 192

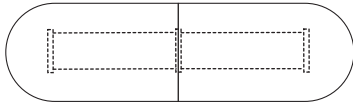

Seating capacity of 16  
Grain direction

Model No.	<b>E/CT-54192-RTO</b>	
Price	16875	23425
Weight	579	1269
	2 piece top/3 panel bases	

60 x 240

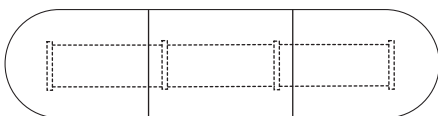



Seating capacity of 20  
Grain direction

Model No.	<b>E/CT-60240-RTO</b>	
Price	21325	34675
Weight	798	1519
	3 piece top/4 panel bases	

**See Pages 46-47 for other base options**  
**See Page 49 for power and data options**

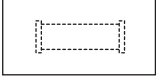
Rectangular Conference Tables

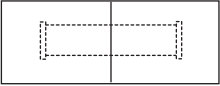
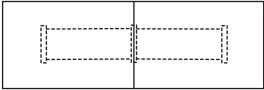
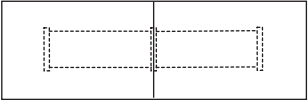
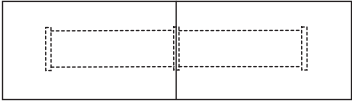
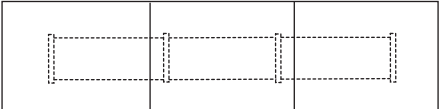
	Veneer Top	Add For Stone Top
42 x 84  Seating capacity of 6 Grain direction <input type="checkbox"/>	Model No. <b>E/CT-4284-R</b> Price 4925 Weight 177 1 piece top/2 panel bases	7950 721
48 x 96  Seating capacity of 8 Grain direction <input type="checkbox"/>	Model No. <b>E/CT-4896-R</b> Price 7050 Weight 220 1 piece top/2 panel bases	10425 827
48 x 120  Seating capacity of 10 Grain direction <input type="checkbox"/>	Model No. <b>E/CT-48120-R</b> Price 7975 Weight 273 2 piece top/2 panel bases	13000 929
48 x 144  Seating capacity of 12 Grain direction <input type="checkbox"/>	Model No. <b>E/CT-48144-R</b> Price 10425 Weight 348 2 piece top/3 panel bases	15600 1009
54 x 168  Seating capacity of 14 Grain direction <input type="checkbox"/>	Model No. <b>E/CT-54168-R</b> Price 11925 Weight 432 2 piece top/3 panel bases	20475 1169
54 x 192  Seating capacity of 16 Grain direction <input type="checkbox"/>	Model No. <b>E/CT-54192-R</b> Price 12975 Weight 483 2 piece top/3 panel bases	23425 1269
60 x 240  Seating capacity of 20 Grain direction <input type="checkbox"/>	Model No. <b>E/CT-60240-R</b> Price 16475 Weight 534 3 piece top/4 panel bases	32500 1519

See Pages 46-47 for other base options  
 See Page 49 for power and data options

Table Base Requirements

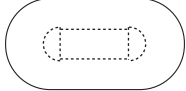
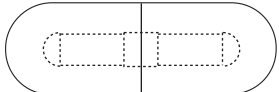
		Square Bases	Half Drum Bases	Drum Bases
Racetrack Oval Conference Tables	42 x 84	NA	(2) HD-18	NA
	48 x 96	NA	(2) HD-21	(2) DB-18
	48 x 120	NA	(2) HD-21	(2) DB-21
	48 x 144	NA	(2) HD-21	(2) DB-21
	54 x 168	NA	(2) HD-24 & (1) SB-24	(3) DB-24
	54 x 192	NA	(2) HD-24 & (1) SB-24	(3) DB-24
	60 x 240	NA	(2) HD-24 & (1) SB-24	(4) DB-27

Rectangular Conference Tables



	42x 84	NA	NA	NA
	48 x 96	(2) SB-18	NA	(2) DB-18
	48 x 120	(2) SB-18	NA	(2) DB-21
	48 x 144	(2) SB-18	NA	(2) DB-21
	54 x 168	(3) SB-21	NA	(3) DB-24
	54 x 192	(3) SB-21	NA	(3) DB-24
	60 x 240	(3) SB-24	NA	(4) DB-27
				

Table Base Options



Panel Base

Add to Table Model No.	Depth	Width	Height	Add to Table Price	Cubic Feet	Weight
<b>PB-21</b>	2 1/4	21	27 3/4	Included in price	0.7	30
<b>PB-24</b>	2 1/4	24	27 3/4	Included in price	0.8	35
<b>PB-27</b>	2 1/4	27	27 3/4	Included in price	0.9	40
<b>PB-30</b>	2 1/4	30	27 3/4	Included in price	1.1	45

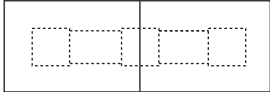
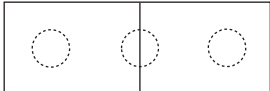
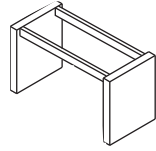
Square Base

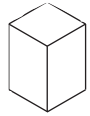

Add to Table Model No.	Depth	Width	Height	Add for Each Square Base	Cubic Feet	Weight
<b>SB-18</b>	18	18	27 3/4	425	6.3	45
<b>SB-21</b>	21	21	27 3/4	450	8.0	60
<b>SB-24</b>	24	24	27 3/4	475	9.3	75

• For electrical access door: Add 500

Half Drum Base







Add to Table Model No.	Depth	Width	Height	Add for Each Half Drum	Cubic Feet	Weight
<b>HD-18</b>	11	18	27 3/4	450	2.0	35
<b>HD-21</b>	12 1/2	21	27 3/4	500	3.5	50
<b>HD-24</b>	14	24	27 3/4	575	1.1	45

• For electrical access door: Add 500

Drum Base

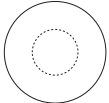
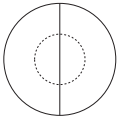
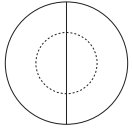

Add to Table Model No.	Diameter	Height	Add for Each Drum	Cubic Feet	Weight
<b>DB-18</b>	18	27 3/4	500	4.0	60
<b>DB-21</b>	21	27 3/4	575	7.1	90
<b>DB-24</b>	24	27 3/4	675	9.0	120
<b>DV-27</b>	27	27 3/4	725	11.0	150

Round Conference Tables w/ Drum Base	Veneer Top	Add For Stone Top
<p>36</p>  <p>Seating capacity of 4</p>	<p>Model No. <b>E/CT-36-RD</b></p> <p>Price 4600</p> <p>Weight 75</p> <p>Base diameter 16"</p>	
<p>42</p>  <p>Seating capacity of 4</p>	<p>Model No. <b>E/CT-42-RD</b></p> <p>Price 5300</p> <p>Weight 88</p> <p>Base diameter 16"</p>	<p>3250</p> <p>4425</p> <p>543</p>
<p>48</p>  <p>Seating capacity of 5</p>	<p>Model No. <b>E/CT-48-RD</b></p> <p>Price 6250</p> <p>Weight 110</p> <p>Base diameter 18"</p>	<p>5800</p> <p>693</p>
<p>54</p>  <p>Seating capacity of 6</p>	<p>Model No. <b>E/CT-54-RD</b></p> <p>Price 7450</p> <p>Weight 135</p> <p>Base diameter 24"</p>	<p>7225</p> <p>867</p>
<p>60</p>  <p>Seating capacity of 7</p>	<p>Model No. <b>E/CT-60-RD</b></p> <p>Price 8325</p> <p>Weight 170</p> <p>Base diameter 27"</p>	<p>9050</p> <p>1061</p> <p>2 piece top</p>
<p>66</p>  <p>Seating capacity of 7</p>	<p>Model No. <b>E/CT-66-RD</b></p> <p>Price 9950</p> <p>Weight 210</p> <p>Base diameter 30"</p>	<p>10850</p> <p>1275</p> <p>2 piece top</p>
<p>72</p>  <p>Seating capacity of 8</p>	<p>Model No. <b>E/CT-72-RD</b></p> <p>Price 10925</p> <p>Weight 225</p> <p>Base diameter 36"</p>	<p>13000</p> <p>1510</p> <p>2 piece top</p>

See Page 49 for power and data options

Conference Table Voice/Data/Power Options

Model No.

Price

Power Sphere

**VDP-PS**

300

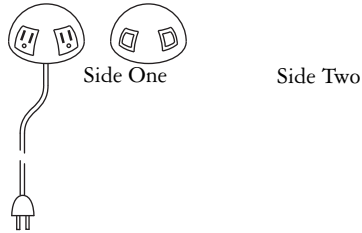

Includes: Two power outlets with 6' cord on side one  
Two RJ-45 data/communications jacks on side two

VDP Pop-up (surface mount)

**VDP-PU**

450

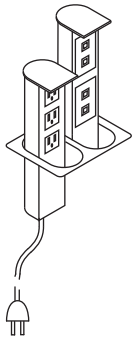

Includes: Three power receptacles with 6' cord  
Four RJ-45 data/communications jacks

VDP Pop-up (below door)

**VDP-HD**

1175

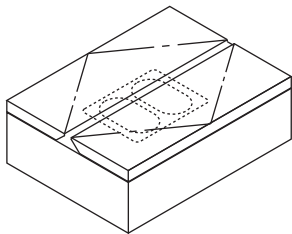

Overall dimension of pair of doors is 9" x 12"  
Includes: VDP-PU  
Access Doors in table top

VDP Power Trough

**VDP-PT**

2175

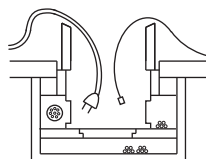
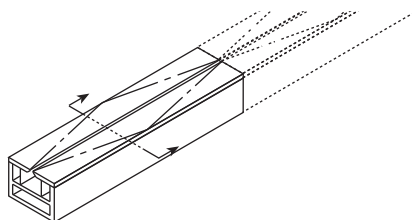

Access Doors Open

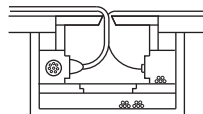

Access Doors Closed

- Each 9" x 36" section contains:
  - Four power receptacles
  - Four RJ-45 data/communications jacks
- Access doors are wood finished to match table top
- Interior is finished matte black
- Power is distributed by means of quick-disconnect power harnesses. The included power feed harness must be hard-wired to the building source.
- Tables generally will have two or more sections depending on the table length. Tables w/ power troughs should have square or half-drum bases to hide the building hook-up.

Specify Model Number and Location

Occasional Tables

Square End Tables

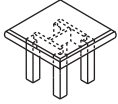

Model No.	Depth	Width	Height	Price	Add for Stone	Cubic Feet	Weight
<b>E/OT-1818-19</b>	18	18	19	1800	1375	6.4	30
<b>E/OT-2424-19</b>	24	24	19	1925	1625	8.0	40
<b>E/OT-3030-19</b>	30	30	19	2050	2050	10.0	55

Rectangular Coffee Tables

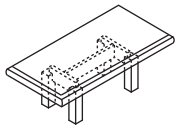

<b>E/OT-2448-16</b>	24	48	16	1700	2750	10.7	65
<b>E/OT-2454-16</b>	24	54	16	1825	3100	12.0	75
<b>E/OT-3054-16</b>	30	54	16	1950	3475	13.5	85

Round End Tables

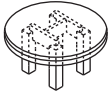

Model No.	Diameter	Height	Price	Add for Stone	Cubic Feet	Weight
<b>E/OC-18-19</b>	18	19	2325	800	6.4	30
<b>E/OC-24-19</b>	24	19	2475	1450	8.0	40
<b>E/OC-30-19</b>	30	19	2600	2250	10.0	55

Round Coffee Tables

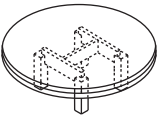

<b>E/OC-30-16</b>	30	16	2750	2250	10.7	65
<b>E/OC-36-16</b>	36	16	2875	3250	12.0	75
<b>E/OC-42-16</b>	42	16	3200	4425	17.0	85

Drum End Tables



<b>E/DT-18-19</b>	18	19	2075	800	2.8	45
<b>E/DT-24-19</b>	24	19	2325	1450	5.0	60
<b>E/DT-30-19</b>	30	19	3050	2250	8.0	90

Drum Coffee Tables

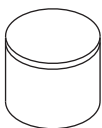

<b>E/DT-24-16</b>	24	16	2300	1450	4.6	60
<b>E/DT-30-16</b>	30	16	2975	2250	6.7	90
<b>E/DT-36-16</b>	36	16	3625	3250	9.4	120

Specify Model Number, Wood Finish, Edge Detail and Optional Accessories

Bookcases

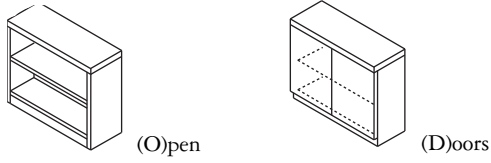

Model No.	Depth	Width	Height	Price	Cubic Feet	Weight
<b>E/B-29-O</b>	14	36	29	1575	8.4	65
<b>E/B-29-D</b>	15	36	29	1950	8.4	86

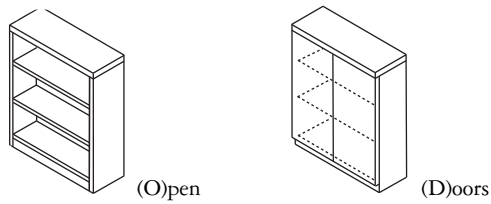

<b>E/B-42-O</b>	14	36	42	2050	12.2	90
<b>E/B-42-D</b>	15	36	42	2550	12.2	104

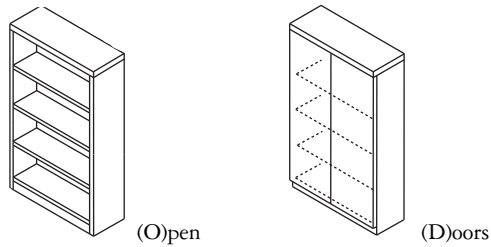

<b>E/B-56-O</b>	14	36	56	2500	16.3	118
<b>E/B-56-D</b>	15	36	56	2875	16.3	132

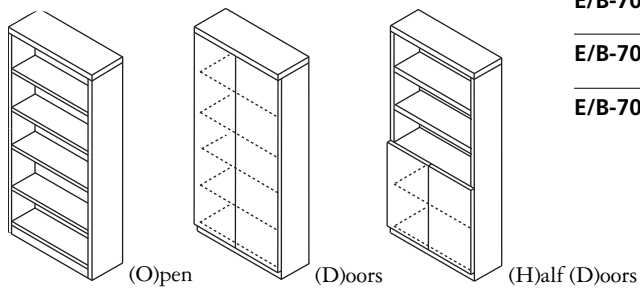

<b>E/B-70-O</b>	14	36	70	2950	20.5	133
<b>E/B-70-D</b>	15	36	70	3450	20.5	158
<b>E/B-70-HD</b>	15	36	70	3250	20.5	152

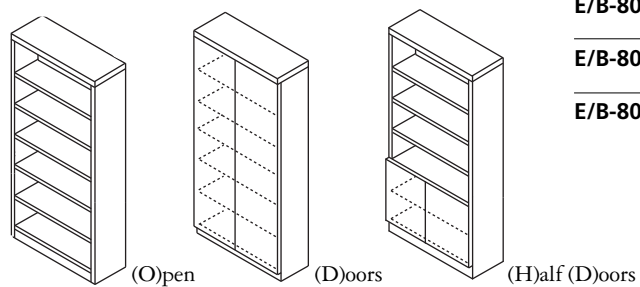

<b>E/B-80-O</b>	14	36	80	3425	23.3	148
<b>E/B-80-D</b>	15	36	80	3625	23.3	180
<b>E/B-80-HD</b>	15	36	80	3500	23.3	172

Specify Model Number, Wood Finish, Edge Detail and Optional Accessories



Architectural Response  
Kollektion, Inc  
2918 Halladay Street  
Santa Ana, California 92705

Tel. 714.241.7100

Fax: 714.241.7600

Toll Free 888.241.7100

Email [info@ark-inc.com](mailto:info@ark-inc.com)

[www.ark-inc.com](http://www.ark-inc.com)

